



Broward County Convention Center

October 2, 2019

EXHIBITOR SERVICE KIT



INDEX



Broward County Convention Center

October 2, 2019

Exhibitor Kit Forms:

Booth Package & Contact Information3
 Exhibit Area Installation & Dismantle Information.....4
 Order Recap Payment & Credit Card Authorization.....5
 Limits of Liability & Responsibility.....6
 Payment Policies.....7
 Standard Booth Furnishings & Carpet.....8
 Booth Cleaning & Porter Services.....9
 Special Signs.....10
 Guidelines for Submitting Graphics.....11
 Intent to Use Non-Official Contractors.....12
 Limits of Liability & Responsibility for Labor.....13
 Labor.....14
 POV.....15
 Material Handling Services & Rates.....16
 Freight Definitions & Information.....17
 Material Handling Special Services.....18
 Shipping Information.....19
 Shipping Instructions (Inbound & Outbound).....20-21
 Limits of Liability for Material Handling.....22
 Shipping Labels (Advance & Showsite).....23-24

Additional Vendor Forms :

- Electrical Services
- Audio/Visual Services
- Telecommunications
- House Carrier/Freight Information
- Accent Furniture



CONTACT AND BOOTH INFORMATION



Broward County Convention Center

October 2, 2019

Dear Exhibitor and/or Sponsors,

KUB Tradeshow Support, LLC is excited in welcoming you to the Naples Condo & HOA Expo. This kit is designed to help navigate you through the exhibit process. It contains important information that can be very helpful in making your experience as an exhibitor a more memorable and successful one .

With KUB Tradeshow Support, LLC, you will experience a more intimate, one on one service which in today’s cyber society has been forgotten. We are here to send our support, our knowledge and our help to ensure that you as the exhibitor are well taken care of and that you have a very successful event.

Below you will find our contact information. Please feel free to contact us with any questions and/or concerns you may have.

All questions regarding the convention space assignments should be directed to:

Broward County Condo & HOA Expo
Layne Knutson
7809 Southtown Center #200
Bloomington, MN 55431
Phone: (800) 374-6463
Email: layneknutson@homeshowcenter.com

All questions regarding shipping, storage, furniture, and labor should be directed to:

Customer Service
KUB Tradeshow Support, LLC
19 North Texas Avenue
Orlando, FL 32805
Phone: (407) 985-3471
Fax: (407) 440-8458
Email: carmenperez@kubtss.com

Also included in this service kit are order forms for various items you may require for your exhibit. **KUB forms are to be returned to our office and the others to the specific contractor who is providing the service.** Please review and submit your order forms as early as possible.

Your 8’ deep by 10’ wide booth is equipped with the following inventory. Additional equipment is available on the forms enclosed:

- 8’ High Black Back Wall
- 1 - 6’ x 30” Black Draped Table
- 2- Chairs
- 3’ High Side Rails - BLACK
- 1 - Wastebasket
- 1 - ID Sign





EXHIBIT
AREA
INSTALLATION
&
DISMANTLE



Broward County Convention Center

October 2, 2019

Set-up Dates & Times

WEDNESDAY October 2, 2019 7:00am - 10:30am

All prefabricated displays must be set and empty crates/boxes tagged for storage by 9:30am, October 2, 2019.

Exhibit Dates & Times

WEDNESDAY October 2, 2019 10:30am - 3:00pm

Dismantle Dates & Times

WEDNESDAY October 2, 2019 3:00pm - 6:00pm

**Forced Freight via YRC
Date & Time**

WEDNESDAY October 2, 2019 6:00pm

Please note: Freight not picked up by the date and time indicated above will be re-routed through the house carrier. Please contact KUB for BOL details.



ORDER RECAP
PAYMENT
&
CREDIT CARD



Broward County Convention Center

October 2, 2019

Please complete the information requested and return payment in full with this form and your orders. You may choose to pay by credit card, check or bank wire transfer. However, we require your authorization to be on file. For your convenience, we will use this authorization to charge your credit card for any additional charges incurred as a result of showsite orders placed by your representative.

Standard Booth Furnishings & Carpet*	\$	_____
Booth Cleaning & Porter Service	\$	_____
Special Signs*	\$	_____
Labor	\$	_____
POV	\$	_____
Material Handling Services	\$	_____
Subtotal:		\$ _____
Add 7% Sales Tax:		\$ _____
Total due:		\$ _____

*Note: Services taxable in the state of FL.

Indicate Payment Method

Check # _____ Dated _____ Amount \$ _____

Charge to: MasterCard VISA American Express
Indicate: Personal Credit Card Company Credit Card

Account #

--	--	--	--	--	--	--	--	--	--	--	--	--	--	--	--	--	--

Expiration Date

--	--	--	--	--	--

PURCHASING CARD: VISA & MASTERCARD REQUIRES YOUR CUSTOMER CODE NUMBER: _____

Cardholder's Name _____
 Cardholder's Address _____ (Print or Type)
 City _____ State _____ Zip _____
 Signature _____
 Company Name _____ Booth# _____
 Street Address _____ Phone# _____
 City _____ State _____ Zip _____ Fax# _____
 Ordered by (Print or Type) _____ E-Mail _____
 Signature _____ Title _____

ALL ORDERS SUBJECT TO LIMITS OF LIABILITY AS SET FORTH ON FOLLOWING PAGE



LIMITS
OF
LIABILITY
&
RESPONSIBILITY



Broward County Convention Center

October 2, 2019

1. KUB Tradeshow Support, LLC shall not be responsible for damage to be uncrated materials, material improperly packed, or concealed.
2. KUB Tradeshow Support, LLC shall not be responsible for loss, theft, or disappearance of exhibitor's material after same has been delivered to exhibitor's booth.
3. KUB Tradeshow Support, LLC shall not be responsible for loss, theft or disappearance of materials before they are picked up from exhibitors' booth for reloading after the show. A Bill of Lading covering outgoing shipments, which is furnished by KUB Tradeshow Support, LLC to the exhibitor, will be checked at time of actual pick-up from booth and corrections made where discrepancies occur.
4. KUB Tradeshow Support, LLC shall not be responsible for any loss, damage or delay due to fire, acts of God, strikes, lockouts or work stoppages of any kind or to any causes beyond its control.
5. KUB Tradeshow Support, LLC liability shall be limited to the physical loss or damage to the specific article which is lost or damaged, and in any event KUB Tradeshow Support, LLC maximum liability shall be limited to \$.30 per pound per article with a maximum liability of \$50.00 per item, or \$1,000.00 per shipment, whichever is less.
6. KUB Tradeshow Support, LLC shall not be liable to any extent whatsoever for any actual, potential or assumed loss of profits or revenues, or for any collateral costs, which may result from any loss or damage to an exhibitor's materials which may make it impossible or impractical to exhibit same.
7. The consignment or delivery of a shipment to KUB Tradeshow Support, LLC by an exhibitor, or by any shipper to or on behalf of the exhibitor, shall be construed as an acceptance by such exhibitor (and/or other shipper) of the terms and conditions set forth.



PAYMENT POLICIES



Broward County Convention Center

October 2, 2019

Payment Options

We offer three convenient ways for you to pay for furniture and carpet rentals, material handling, signs and other services provided by KUB Tradeshow Support, LLC in our role as the Official Contractors for this show.

1. All checks must be in U.S. funds drawn on a U.S. bank.

2. Advance Payment by Company Check

Please make all checks payable to KUB Tradeshow Support, LLC .Attach check to order forms. Additionally, although you may choose to pay by company check or cash for charges incurred at show site, **we require your signed Payment and Credit Card Charge Authorization form to be on file with KUB Tradeshow Support, LLC.**

3. Wire Transfer in U.S. Funds

Bank information call KUB Tradeshow Support, LLC (407) 985-3471 or e-mail: carmenperez@kubtss.com

Wire transfers must be initiated and confirmed at least two weeks before move-in.

Wire transfers must include the show name, company name and booth number.

Due to various processing fees we incur from banks clearing wire transfers into our accounts,

KUB will charge the following fees:

Domestic incoming wire transfer fee: \$25.00

International incoming wire transfer fee: \$35.00

4. Credit Card

Use MasterCard, VISA or American Express. To accept charges, you must complete the PAYMENT AND CREDIT CARD AUTHORIZATION form on the page 5. For discount rates to apply, KUB Tradeshow Support, LLC, must receive this form by the deadline dates located on the top of the pages that pertain to services in need of deadline date.

Showsite Orders

To save money, take advantage of the pre-show discounts by ordering as many of your requirements as possible before the Discount Deadline Date. ***For the discount prices to be in effect, your order must be received by the Discount Deadline Date, and payment must accompany your order.*** Orders received after the Discount Deadline Date or made at the Exhibitor Service Desk during the show will be billed at the “standard” prices listed on the various forms.

Payment Terms

To process your order for services and materials listed in the Exhibitor Service Manual, **we require your signed Payment and Credit Card Charge Authorization form to be on file** with KUB Tradeshow Support, LLC in advance to guarantee payment. Invoices for outstanding balances will be available at the Exhibitor Service Desk for your review and payment. Prepayments will be indicated, and any balance due must be paid in full by cash, check or credit card upon presentation. All payment inquiries should be resolved before you leave the show.

Invoices will be distributed the last day of the show. If you have any concerns about your charges for inbound freight, installation labor, furniture or accessories, please stop by the Exhibitor Service Desk. Charges for these items may not be disputed after the show.

Additionally, KUB Tradeshow Support, LLC is authorized to charge the exhibitor's credit card for any charges incurred following the show, i.e. dismantle labor, outbound overtime drayage charges, etc. In these circumstances, KUB will charge the exhibitor's credit card on file, and mail an invoice to the exhibitor, outlining charges which were billed.

All charges payable in U.S. Funds only. Checks, cash, Traveler's checks, MasterCard, VISA and American Express are accepted. ***Telephone orders are not accepted.***

Cancellation Policy:

Items cancelled before the deadline date will be refunded at 50%. **NO REFUNDS AFTER DEADLINE DATE.**



STANDARD BOOTH
FURNISHINGS
&
CARPET



DEADLINE DATE: Tues., 9/17/19

Broward County Convention Center

October 2, 2019

Rental price includes delivery to and removal from your booth.

QTY.		DISCOUNT RATES	STANDARD RATES	AMT.
SEATING				
_____	Side Chair.....	\$ 52.50	\$ 68.25	_____
_____	Padded Stool.....	\$100.35	\$130.75	_____
ACCESSORIES				
_____	Round Pedestal Table (30"h x 30"d)...	\$ 87.40	\$111.02	_____
_____	Round Pedestal Table (42"h x 30"d)....	\$111.05	\$143.85	_____
_____	Wastebasket.....	\$ 25.80	\$ 33.35	_____
_____	Easel.....	\$ 29.15	\$ 37.80	_____
_____	Chrome Sign Frame (22" x 28").....	\$ 76.65	\$ 87.15	_____
_____	Bag Holder.....	\$103.95	\$136.50	_____
_____	8' Stanchion.....	\$ 29.15	\$ 37.80	_____
_____	Crossbar.....	\$ 29.15	\$ 37.80	_____
_____	Garment Rack.....	\$103.95	\$136.50	_____
_____	Literature Rack.....	\$103.95	\$136.50	_____

STANDARD CARPET

Price includes installation & taping front edge.

No guarantee of color match when ordering multiple carpets.

_____	10' x 10'.....	\$128.90	\$167.75	_____
_____	10' x 20'.....	\$258.85	\$335.25	_____
_____	10' x 30'.....	\$385.90	\$502.45	_____
_____	10' x 40'.....	\$490.25	\$669.90	_____
_____	10' x 50'.....	\$643.15	\$837.40	_____

Circle color: Blue | Burgundy | Gray | Teal | Red | Black | Hunter Green

CUSTOM SIZE CARPET

Price includes installation to fit booth space, protective covering, and edges taped.

INDICATE OVERALL DIMENSIONS:

_____ ft. x _____ ft. (100 sq. ft. minimum) \$3.15 sq. ft. \$3.95 sq. ft. _____

Circle color: Blue | Burgundy | Gray | Teal | Red | Black | Hunter Green

INDICATE OVERALL DIMENSION:

_____ ft. x _____ ft. (100 sq. ft. minimum) \$1.35 sq. ft. \$1.60 sq. ft. _____

QTY.		DISCOUNT RATES	STANDARD RATES	AMT.
DRAPED DISPLAY TABLES - 30" HIGH				
Price includes white vinyl top & 3 sides				
Circle color: Blue Black Burgundy Purple Gray Red Teal White Hunter Green				

_____	2' x 4' x 30".....	\$107.65	\$136.50	_____
_____	2' x 6' x 30".....	\$121.55	\$155.40	_____
_____	2' x 8' x 30".....	\$145.95	\$189.80	_____
_____	4th Side Drape 6' & 8' Only.....	\$ 38.35	\$ 81.90	_____

DRAPED DISPLAY TABLES - 42" COUNTER HIGH

Price includes white vinyl top & 3 sides

Circle color: Blue | Black | Burgundy | Purple | Gray | Red | Teal
White | Hunter Green

_____	2' x 4' x 42".....	\$154.10	\$200.30	_____
_____	2' x 6' x 42".....	\$168.55	\$219.20	_____
_____	2' x 8' x 42".....	\$195.25	\$252.30	_____
_____	4th Side Drape 6' & 8' Only.....	\$38.35	\$ 81.90	_____

UNDRAPED DISPLAY TABLES - 30" HIGH

_____	2' x 4' x 30".....	\$ 54.10	\$ 85.35	_____
_____	2' x 6' x 30".....	\$ 66.45	\$100.55	_____
_____	2' x 8' x 30".....	\$ 79.55	\$103.70	_____

UNDRAPED DISPLAY TABLES - 42" HIGH

_____	2' x 4' x 42".....	\$ 66.70	\$ 85.35	_____
_____	2' x 6' x 42".....	\$ 77.45	\$100.55	_____
_____	2' x 8' x 42".....	\$ 90.60	\$117.35	_____

DRAPED RISERS

White Vinyl				
_____	4' One Step.....	\$ 52.25	\$ 67.50	_____
_____	6' One Step.....	\$ 67.75	\$ 87.70	_____
Raise & Drape Package				
_____	Table to 42" high.....	\$ 69.05	\$ 81.90	_____

PAYMENT POLICY: Payment in full of rental charges including applicable tax, must accompany your advance order prior to Deadline Date to qualify for discount rates. All orders received after deadline date or placed at the the Service Desk will be invoiced at standard rates. Invoices must be settled at the Service Desk prior to show closing. No telephone orders accepted. **CANCELLATION POLICY:** Items cancelled before the deadline date will be refunded at 50%. **NO REFUNDS AFTER DEADLINE DATE.**

ALL CHARGES SUBJECT TO (7%) SALES TAX
FULL PAYMENT MUST ACCOMPANY ORDER
TOTAL ALL ITEMS ORDERED
ATTACH TO ORDER RECAP & CREDIT CARD AUTHORIZATION FORM
ENTER TOTAL

Company Name _____ Booth # _____
 Street Address _____ Phone # _____
 City _____ State _____ Zip _____ Fax # _____
 Ordered by (Print or Type) _____ E-Mail _____
 Signature _____ Title _____



**BOOTH
CLEANING
&
PORTER
SERVICES**
DEADLINE DATE: Tues., 9/17/19



Broward County Convention Center

October 2, 2019

Please indicate your requirements and totals below:

BOOTH CLEANING

- Daily - Vacuuming.....\$.37 per sq. ft.
- Once - Vacuuming before initial opening.....\$.42 per sq. ft.

**Calculate total:
(Minimum charge: 100 Sq. Ft. Per Day)**

Size of booth: _____ x _____ = _____ sq. ft. x rate: _____ x No. Of Days: _____ = \$ _____

NOTE: All rental carpets are delivered clean to your booth space. However, during set-up, the carpet can become spoiled. We suggest you order cleaning service at least once prior to show opening.

PORTER SERVICE

KUB Tradeshow Support, LLC will assign (1) man every hour (maximum of 8 hours per day) during show hours to your booth for removal of excess trash. This service is being provided to all exhibitors at a **\$1.05 per square foot per day after a minimum charge of 100 square feet.**

**Calculate total:
(Minimum charge: 100 Sq. Ft. Per Day)**

Size of booth: _____ x _____ = _____ sq. ft. x rate: **\$1.05** x Number Of Days: _____ = \$ _____

PAYMENT POLICY: Payment in full of rental charges including applicable tax, must accompany your advance order prior to Deadline Date to qualify for discount rates. All orders received after deadline date or placed at the the Service Desk will be invoiced at standard rates. Invoices must be settled at the Service Desk prior to show closing. No telephone orders accepted. **CANCELLATION POLICY:** Items cancelled before the deadline date will be refunded at 50%. **NO REFUNDS AFTER DEADLINE DATE.**

FULL PAYMENT MUST ACCOMPANY ORDER
TOTAL ALL ITEMS ORDERED
ATTACH TO ORDER RECAP & CREDIT CARD AUTHORIZATION FORM
ENTER TOTAL

Company Name _____ Booth # _____
Street Address _____ Phone # _____
City _____ State _____ Zip _____ Fax# _____
Ordered by (Print or Type) _____ E-Mail _____
Signature _____ Title _____

MAIL OR FAX TO KUB TRADESHOW SUPPORT, LLC BEFORE DEADLINE DATE



SPECIAL SIGNS



DEADLINE DATE: Mon., 9/23/19

Broward County Convention Center

October 2, 2019

Qty	Size	Advance Prices	Deadline Price	Amount
_____	7" x 44"	\$38.35	\$47.80	\$_____
_____	14" x 22"	\$54.60	\$68.25	\$_____
_____	22" x 28"	\$81.90	\$102.40	\$_____
_____	28" x 44"	\$114.75	\$143.35	\$_____
_____	1 Meter x 8'	\$191.10	\$238.90	\$_____
_____	30" round graphic for pedestal tables**	\$78.75	\$98.45	\$_____

** (please call or email for details, measurements, or questions)

- Easel back applied to sign quoted upon request.
 - All prices are for single sided-double sided quoted upon request.
 - Special sizes and materials quoted upon request.
- Delivery time is not guaranteed on orders placed at showsite.
 - All orders must be received ten days before show opens. Orders after Deadline Date will be subject to an additional 25% fee.**
 - Please utilize one of the following programs: Adobe Acrobat Professional 8.0, Adobe Illustrator CS5, Photoshop CS5, or Adobe InDesign CS5. For further details, refer to the Graphic Guidelines page.

Vertical

Horizontal

Color of Background

Color of Lettering

Please type desired copy below or attach a separate sheet

PAYMENT POLICY: Payment in full of rental charges including applicable tax, must accompany your advance order prior to Deadline Date to qualify for discount rates. All orders received after deadline date or placed at the the Service Desk will be invoiced at standard rates. Invoices must be settled at the Service Desk prior to show closing. No telephone orders accepted. **CANCELLATION POLICY:** Items cancelled before the deadline date will be refunded at 50%. **NO REFUNDS AFTER DEADLINE DATE.**

ALL CHARGES SUBJECT TO (7%) SALES TAX
 FULL PAYMENT MUST ACCOMPANY ORDER
 TOTAL ALL ITEMS ORDERED
 ATTACH TO ORDER RECAP & CREDIT CARD AUTHORIZATION FORM
 ENTER TOTAL

Company Name _____ Booth # _____
 Street Address _____ Phone # _____
 City _____ State _____ Zip _____ Fax# _____
 Ordered by (Print or Type) _____ E-Mail _____
 Signature _____ Title _____

MAIL OR FAX TO KUB TRADESHOW SUPPORT, LLC BEFORE DEADLINE DATE



GUIDELINES FOR SUBMITTING GRAPHICS



Broward County Convention Center

October 2, 2019

E-mail: Vivian@KUBTSS.com

We can accept graphic files created with the following programs:

Adobe Acrobat Professional 8.0

Adobe Illustrator CS5

Photoshop CS5

Adobe InDesign CS5

We prefer to work with Adobe Acrobat high resolution PDF files. However we will also accept:

Artwork saved as vector files, which can be resized without losing resolution.

ALL vector files MUST have fonts converted to outlines or curves, and/or include all the fonts which you have used to create your files (True or Open Type Font only).

Any bitmapped or raster files, such as .tif, .bmp, .jpeg, must be of sufficient resolution to print properly at the intended dimensions, resolution should be 300 dpi on a half size graphic or actual size graphic at 90-120 dpi. If uncertain as to requirements, please consult us before sending files

(Note: No bleeds needed on printable files)

Files which have been created for web publication, or logos which are scanned from letterheads are NOT accepted for large format digital printing.

We are not responsible for spelling mistakes on text or low resolution images sent by clients. A fee applies for replacing the sign.

Color Matching

Please provide a method for us to accurately reproduce the colors you require for your graphics. Colors specified using the Pantone ® color matching system is the preferred method.

Sending Files

Files which are not overly large can be sent by e-mail to email shown above. You may send larger files via Dropbox or wetransfer. You may also send us a CD to:

KUB Tradeshow Support, LLC

Attention: Vivian Garcia

19 North Texas Avenue

Orlando, FL 32805

If you have any questions, please contact us before sending your files.



INTENT TO USE
NON-OFFICIAL
CONTRACTORS



DEADLINE DATE: Tues., 9/17/19

Broward County Convention Center

October 2, 2019

A Non-Official Contractor is: Any individual who is not a full-time permanent employee of an exhibiting firm, who is providing a service to an exhibitor on-site at the convention facility and does not represent one or more of the official contractors.

1. Exhibitors who choose to use a Non-Official Contractor must complete and sign this form. It must be received at KUB Tradeshow Support, LLC no later than the **Deadline Date** shown above. No extensions or exceptions will be granted after the published deadline.
2. The Non-Official Contractor must provide KUB Tradeshow Support, LLC with a valid and current Certificate of Insurance naming KUB Tradeshow Support, LLC as the Certificate Holder. This certificate must be received no later than the **Deadline Date** shown above. No extensions or exceptions will be granted after the published deadline.
3. Failure to provide KUB Tradeshow Support, LLC with the above items 1 and 2 will result in said firms being required to hire installation and dismantling labor from KUB. Non-official contractors will be able to provide supervision only.
4. All representatives of the Non-Official Contractors must obtain an Exhibit Crew badge at the KUB Labor Desk.

Exhibiting Firm: _____ Booth #: _____

Authorized Name & Title: _____

Authorized Signature: _____

Full Name of Non-Official Contractor: _____

Complete Address: _____

City, State: _____ Zip Code: _____

Phone Number: _____ Fax Number: _____

Non-Official Contractor Showsite Representative: _____

Type of Service to Be Performed:

Retain one copy for your files.



LABOR
LIMITS OF LIABILITY
&
RESPONSIBILITY



Broward County Convention Center

October 2, 2019

1. KUB Tradeshow Support, LLC shall not be responsible for damage to uncrated materials, materials that are improperly packed and/or concealed.
2. KUB Tradeshow Support, LLC shall not be responsible for loss, theft, or disappearance of exhibitor's materials after same has been delivered to exhibitor's booth.
3. KUB Tradeshow Support, LLC shall not be responsible for loss, theft or disappearance of materials before they are picked up from exhibitor's booth for reloading after the show. A Bill-of-Lading covering outgoing shipments, which is furnished by KUB Tradeshow Support, LLC to exhibitor, will be checked at time of actual pick-up from booth and corrections made where discrepancies occur.
4. KUB Tradeshow Support, LLC shall not be responsible for any loss, damage or delay due to fire, acts of God, strikes, lockouts or work stoppages of any kind or to any causes beyond its control.
5. KUB Tradeshow Support, LLC liability shall be limited to the physical loss or damage to the specific article which is lost or damaged, and in any event KUB Tradeshow Support, LLC maximum liability shall be limited to \$.30 per pound per article with a maximum liability of \$50.00 per item, or \$1,000.00 per shipment, whichever is less.
6. KUB Tradeshow Support, LLC shall not be liable to any extent whatsoever for any actual, potential or assumed loss of profits or revenues, or for any collateral costs, which may result from any loss or damage to an exhibitor's materials which may make it impossible or impractical to exhibit same.
7. The consignment or delivery of a shipment to KUB Tradeshow Support, LLC by an exhibitor or by any shipper, to or on behalf of the exhibitor, shall be construed as an acceptance by such exhibitor of all terms and conditions set forth in this exhibitor kit..



LABOR



DEADLINE DATE: Tues., 9/17/19

Broward County Convention Center

October 2, 2019

Display Labor for Installation and Dismantling of Exhibits

Display Labor Rates:

Straight Time
 \$69.85 per hour
 One hour minimum per worker
 Thereafter 1/2 hr. increments

ST: 8:00AM to 4PM
 Monday through Friday

Overtime
 \$104.75 per hour
 One hour minimum per worker
 Thereafter 1/2 hr. increments

OT: Before 8:00AM and after 4PM
 Monday through Friday and all hours
 on Saturday and Sunday

ALL LABOR ORDERS RECEIVED AFTER THE ABOVE SPECIFIED DEADLINE DATE WILL BE CHARGED AN ADDITIONAL 25%

PLEASE NOTE: 8:00 AM is the only guaranteed starting time. All the other orders will be filled as labor is available. **All labor must be signed in/out at the Service Desk.** Exhibitors not checked in by their requested starting times are subject to a 1 hour minimum charge per man ordered, unless we received written cancellation 24 hours prior to starting time.

Please indicate the type of labor requested:

____ **PLAN A - EXHIBITOR'S SUPERVISION** - All work performed must be under the supervision of the Exhibitor.

	No. Men	Date	Time	Approx. Hours
Set-up				
Dismantle				

____ **PLAN B - KUB SUPERVISION** - Hourly rate plus 35% Supervision Charge with a Minimum charge of \$42.00.

Name of Carrier _____ # Crates _____ Cartons _____ Skids _____

Shipped to: _____ Warehouse _____ Showsite _____ Display Includes Carpet _____ KUB's Rental Carpet _____

SET-UP DIAGRAMS MUST BE INCLUDED WITH LABOR ORDER PLAN B: KUB SUPERVISION

After Dismantle Return Display To (Shipping Address): _____

_____ **VIA:** _____

KUB shall not be responsible for damage, loss, or theft of display installed and/or dismantled under our Supervision. KUB shall not be responsible for loss, theft, or disappearance of materials before they are picked up from exhibitor's booths for reloading after the show.

PAYMENT POLICY: CREDIT CARD INFORMATION MUST BE ON FILE FOR SET-UP & DISMANTLE LABOR ORDERS

Company Name _____		Booth _____																																										
Street Address _____		Phone # _____																																										
City _____	State _____	Zip _____	Fax# _____																																									
Ordered by (Print or Type) _____		E-Mail _____																																										
Signature _____		Title _____																																										
CREDIT CARD: <input type="checkbox"/> M/C <input type="checkbox"/> VISA <input type="checkbox"/> AMEX		ACCOUNT NUMBER: <table border="1" style="width:100%; height:20px;"> <tr> <td style="width:10%;"></td> <td style="width:10%;"></td> <td style="width:10%;"></td> <td style="width:10%;"></td> <td style="width:10%;"></td> <td style="width:10%;"></td> <td style="width:10%;"></td> <td style="width:10%;"></td> <td style="width:10%;"></td> <td style="width:10%;"></td> <td style="width:10%;"></td> <td style="width:10%;"></td> <td style="width:10%;"></td> <td style="width:10%;"></td> <td style="width:10%;"></td> <td style="width:10%;"></td> <td style="width:10%;"></td> <td style="width:10%;"></td> <td style="width:10%;"></td> <td style="width:10%;"></td> </tr> </table>																					EXPIRATION DATE: <table border="1" style="width:100%; height:20px;"> <tr> <td style="width:10%;"></td> <td style="width:10%;"></td> <td style="width:10%;"></td> <td style="width:10%;"></td> <td style="width:10%;"></td> <td style="width:10%;"></td> <td style="width:10%;"></td> <td style="width:10%;"></td> <td style="width:10%;"></td> <td style="width:10%;"></td> <td style="width:10%;"></td> <td style="width:10%;"></td> <td style="width:10%;"></td> <td style="width:10%;"></td> <td style="width:10%;"></td> <td style="width:10%;"></td> <td style="width:10%;"></td> <td style="width:10%;"></td> <td style="width:10%;"></td> <td style="width:10%;"></td> </tr> </table>																					
CARDHOLDERS SIGNATURE: _____					CARDHOLDERS NAME: _____																																							



POV



DEADLINE DATE: Tues., 9/17/19

Broward County Convention Center

October 2, 2019

KUB Tradeshow Support, LLC will provide labor to unload a POV (Personally Owned vehicles defined as station wagons, mini vans, SUV's, etc.) at showsite only during Exhibitor move in schedule as outlined on page 4 of this exhibitor kit.

Unloading of POV

The advance rate for this service is **\$75.00 per vehicle, one way, 500 lbs. maximum** (this form must be received by the deadline date indicated above). Showsite service will be provided at a rate of \$85.00 per vehicle. Exhibitors may carry in their own freight (NO USE OF KUB FORKLIFT, PALLET JACKS, DOLLIES etc. - **HAND CARRY ONLY**) and will not be subject to Material Handling charges unless exhibitor requires use of forklift dollies, flat carts, or pallet jacks. Exhibitors are responsible for the storage of their own empties. KUB can store empties for an additional fee. This service can be provided by KUB as outlined on page 18.

Unloading of Pallets

Pallet rate for trucks such as pick ups or vans on-site from the dock to the booth is advance rate \$93.75 up to 1000 lbs. one way dock height. (must be able to unload at the dock). Showsite rate is \$103.75 per pallet.

_____ **POV- 500 LBS MAX AT \$75.00 EACH WAY**

_____ **NUMBER OF PALLETS TO BE UNLOADED AT \$93.75 EACH , 1000 LBS MAX**

THIS AUTHORIZATION MUST BE COMPLETED BELOW AND PROCESSED TO KUB TRADESHOW SUPPORT, LLC BEFORE POV SHIPMENTS CAN BE HANDLED.

Company Name _____										Booth _____																			
Street Address _____															Phone # _____														
City _____										State _____					Zip _____					Fax # _____									
Ordered by (Print) _____															E-Mail _____														
Signature _____															Title _____														
CREDIT CARD: <input type="checkbox"/> M/C <input type="checkbox"/> VISA <input type="checkbox"/> AMEX															ACCOUNT NUMBER:										EXPIRATION DATE:				
CARDHOLDERS SIGNATURE:															CARDHOLDERS NAME:														



MATERIAL
HANDLING
SERVICES
&
RATES
DEADLINE DATE: Wed., 9/25/19



Broward County Convention Center

October 2, 2019

Advance Shipments to KUB Warehouse

Advance Shipments will be received at the Advance Warehouse beginning Monday, September 2, 2019. Please round off to the nearest 100 lbs. Please note: 200 lb. Minimum for this service)

Crated and/or skidded

Shipment Weight _____ x \$0.58/lb.= \$ _____

Uncrated or Unskidded Shipments requiring special handling

Shipment Weight _____ x \$.87/lb.= \$ _____

Small Package Shipment - Total Shipment Weight 35 lbs or less

Small Package Shipment _____ x \$35.00 ea. =\$ _____

Direct Shipments to Show Site

Direct shipments will be received starting on Wednesday, October 2, 2019 at 8:00am. Shipments that arrive prior to this date may be refused by the facility as KUB will not have staff present prior to this date and time. Please round off to the nearest 100 lbs.

Crated or Uncrated

Shipment Weight _____ x \$64./lb.= \$ _____

Uncrated or Unskidded Shipments requiring special handling

Shipment Weight _____ x \$92lb.= \$ _____

Small Package Shipment (Total Shipment Weight of 50 lbs or less)

Small Package Shipment _____ x \$40.00 ea. = \$ _____

All shipments accepted and moved in or out on overtime will be charged 25% in addition to the above rates.

*Total estimated Material Handling \$ _____

*Please fill out Payment & Credit Card and Authorization form on page 5 of this exhibitor kit. We understand that your calculation is only an estimate. Invoicing will be completed from the actual weight as listed on the inbound bills of lading. Adjustments will be made accordingly. Adjustments must be paid at showsite. If you have any questions about material handling, please contact KUB Tradeshow Support, LLC Exhibitor Service Department.



FREIGHT DEFINITIONS & INFORMATION



Broward County Convention Center

October 2, 2019

Crated and/or skidded Floor Load Shipments: Crated and/or floor load shipments that can be unloaded at the dock without additional handling (such as ground loading, side door loading, constricted space loading, designated piece loading or stacked shipments) required.

Uncrated, Unskidded, Wrapped Shipments and Crated Shipments Requiring Special Handling: Uncrated, unskidded or wrapped shipments. These rates also apply to shipments that are loaded and charged by cubic space and/or packed in such a manner to require additional handling (such as ground loading, side door loading, constricted space loading, designated piece loading or stacked shipments). FedEx and UPS are included in this category due to their delivery procedures and documentation.

Small Package Shipments: Packages or envelopes received at warehouse or show site with Maximum weight per shipment of 35 lbs. requiring no round trip. Packages or envelopes without documentation will be delivered without guarantee of piece count or conditions

Freight/Overtime Rates: All freight received at the warehouse and/or showsite that must be moved in or out of the booth before 8:00 AM or after 4:00 PM on weekdays or all day Saturdays, Sundays and holidays. KUB is not responsible for the scheduling of move in, show days and move out dates and time.

Special Handling: Shipments that are loaded in such a manner as to require additional labor to unload, sort and deliver. Requires a surcharge for material handling and is defined as follows:

Ground Load/Unload: Vehicles that are not dock height preventing the use of loading docks, such as U-Hauls, flat bed trailers, double drops, etc. Situations where dock utilization is not possible will result in a Special Handling assessment.

Side Door Load/Unload: Shipments that cannot be accessed from the rear of the trailer.

Constricted Space Load/Unload: Trailers loaded 'high and tight', shipments that are loaded in such a manner as to not be readily available (freight down one side of a trailer that must be by-passed to reach targeted freight).

Designated Piece Load: Driver with tape measure who requires loading crew to bring multiple pieces of freight to rear of trailer to select next piece; having to unload and reload to fit, etc.

Stacked Shipments: Shipments loaded in such a manner as to require items to be removed to ground level for delivery to booth. Loose items stacked on top of crates and/or pallets constitute special handling.

Mixed Shipments: Multiple shipments delivered together without shipment integrity; pieces for separate shipments that are loaded mixed throughout the delivery vehicle, such as UPS, FedEx, DHL, USPS.



MATERIAL HANDLING SPECIAL SERVICES



Broward County Convention Center

October 2, 2019

Empty Storage

Those exhibitors who elect to **hand-carry in one trip** items into the exhibit hall without the assistance of KUB Tradeshow Support, LLC or use the POV Service may acquire on-site storage for empty containers based on the following rates: \$ 20.00 per pallet, \$15.00 per carton and \$25.00 per fiber case. This service includes removing empties from your booth, storing them during the show and returning them to your booth after show closing.

Mobile and Immobile Unit Spotting

Exhibitors authorized by show management to bring a motorized unit or an immobile unit that requires KUB to tow into the exhibit hall , you will be required to hire KUB Tradeshow Support, LLC supervision services. Please see page 24 of this manual for rates. A representative from KUB Tradeshow Support, LLC will escort each vehicle into and out of the exhibit facility to provide safe access and minimize liabilities.

Shipments Returned to Warehouse

At the close of show, for re-forwarding or storage, there will be an additional charge for shipments returned to our warehouse. The initial and minimum fee is \$52.50 up to the first 100 lbs. which includes UPS & FEDEX shipments. For shipments over 100 lbs., a fee of \$31.50 per cwt. on straight time and \$36.75 per cwt. on overtime will apply. Warehouse storage space is limited. Please call our Customer Service Department at (407) 985-3471 to confirm availability prior to show.

Special Rates and Services

Steel banding is available at \$1.10 per linear foot, plus one-half hour minimum labor.



SHIPPING INFORMATION



Broward County Convention Center

October 2, 2019

What you should know:

- * As an exhibitor, you are responsible for providing your carrier with proper delivery and pickup information for your materials, both in advance and at showsite.
- * Please prepay all shipping charges. KUB Tradeshow Support, LLC cannot accept or be responsible for collect shipments. All shipments must be accompanied by a Bill-of-Lading. Shipments received without receipts, freight bills or specified unit counts (UPS, Federal Express, personal vehicles, etc.) will be delivered to the exhibitor's booth without guarantee of piece count or condition. No liability will be assumed by KUB Tradeshow Support, LLC for such shipments. Shipments without certified weight documents will be estimated by KUB Tradeshow Support, LLC. This estimate will be binding on both parties and no adjustments will be made after the show closes.
- * **Do not ship uncrated materials to the warehouse. Loose, uncrated or unskidded materials will be accepted at showsite only. Uncrated shipments received at showsite are charged at higher handling rates than crated, skidded or otherwise self-contained shipments.**
- * Separate mixed van shipments between crated and uncrated. Clearly identify the weights of each on the Bill-of-Lading. Otherwise, KUB Tradeshow Support, LLC will invoice the entire load at the uncrated rate and will be unable to adjust the charges later.
- * Select your carrier carefully. Shipments received on vehicles that cannot be unloaded at the dock are considered 'special handling' and are charged at higher rates.
- * All shipments for the show received either in advance or at showsite will be charged material handling by KUB Tradeshow Support, LLC. Refer to the *Material Handling Service and Rates Form on page 16*.
- * All material handling rates are roundtrip and are based on incoming weights only. Overtime charges may apply under some circumstances. Please refer to the *Material Handling Service and Rates Form on page 16*.
- * If granted permission for early move-in (off-target move-in) by show management and KUB Tradeshow Support, LLC, the exhibitor is required to use KUB Tradeshow Support, LLC labor for booth installation.

Material Handling includes:

- * Storing your booth in our warehouse for up to 30 days in advance of the show. (Advance shipments only)
- * Delivering materials to your booth at showsite.
- * Removing empty containers from your booth, storing them for the duration of the show, then returning them to your booth at close of the show.
- * Moving packed and labeled materials from your booth to the dock area at close of show and reloading them on designated vehicles based on information provided on your showsite Bill-of-Lading.

Material Handling DOES NOT include:

- * Labor and/or equipment for uncrating, unskidding, assembling, positioning, leveling, dismantling, recrating and reskidding of machinery and/or equipment for exhibitors.
- * Scheduling any carrier for pick up or delivery of your materials, if other than the official show carrier(s).



SHIPPING
INSTRUCTIONS
(INBOUND)



DEADLINE DATE: Wed., 9/25/19

Broward County Convention Center

October 2, 2019

KUB Tradeshow Support, LLC is prepared to receive your shipment either in advance at our local warehouse or directly at the exhibit site. You may ship via the carrier of your choice.

Rates are based on the incoming weight of shipments. **For rate information, see the MATERIAL HANDLING SERVICE AND RATES order form on page 16. KUB Tradeshow Support, LLC must have payment before forwarding freight.**

SHIPPING IN ADVANCE TO THE WAREHOUSE:

All advance shipments to the warehouse should be addressed/labeled as follows:

**TO: Broward County Condo & HOA EXPO
Exhibiting Company's Name & Booth Number
C/O KUB Tradeshow Support, LLC
19 North Texas Avenue
Orlando, FL 32805**

- **To trace your shipment, please contact the Customer Service Department at (407) 985-3471 or email- carmenperez@kubtss.com.**
- Shipments will be received beginning **Mon, September 2, 2019.**
- Shipments received after the deadline of **Wednesday, September 25, 2019** will be charged an additional 25% surcharge.
- Shipments received after **4:00PM** will be charged an **overtime rate.**
- Advance warehouse receiving hours are **Monday through Friday, 8:00AM to 4:00PM**
- Carriers checking in **after 4:00PM Monday through Friday** will not be guaranteed unloading.

SHIPPING DIRECTLY TO SHOWSITE:

All direct shipments to showsite should be addressed/labeled as follows:

**TO: Broward County Condo & HOA EXPO
Exhibiting Company's Name & Booth Number
C/O KUB Tradeshow Support, LLC
Broward County Convention Center
1950 Eisenhower Blvd.
Ft. Lauderdale, FL 33316**

Showsite shipments will be received beginning Wednesday October 2, 2019 from 8am - 10:30am



SHIPPING INSTRUCTIONS (OUTBOUND)



Broward County Convention Center

October 2, 2019

Shipping Outbound from Showsite

- All outbound shipments must be accompanied by an official show Bill-of-Lading.
• You may obtain show Bills of Lading after reviewing your invoice at showsite.
• When shipping to separate destinations, a separate Bill-of-Lading is required for each destination.
• All outbound shipments should be addressed/labeled as follows:

FROM: Exhibitor Name
BOOTH #:
SHOW NAME: Broward County Condo & HOA EXPO
LOCATION: Broward County Convention Center
TO: Shipping Address

- Once your shipment is packed and labeled, return your show Bill-of-Lading to the KUB Tradeshow Support, LLC Service Desk.
• All Bill-of-Ladings must be turned in no later than 5:00pm on Wed., October 2, 2019.

DO NOT LEAVE BILLS OF LADING IN YOUR BOOTH!

- Failure to turn in your show bill of lading by the designated deadline may result in additional overtimes charges and/or the rerouting of your materials.
• Be sure to confirm pickup day(s) and time(s) with your selected carrier. All outside carriers (carriers other than YRC must be checked in no later than 4pm on Wed., October 2, 2019.



LIMITS OF LIABILITY FOR MATERIAL



Broward County Convention Center

October 2, 2019

Limits of Liability for Material Handling

- * KUB Tradeshow Support, LLC shall not be responsible for damage to uncrated materials, material improperly packed, or concealed damage.
- * KUB Tradeshow Support, LLC shall not be responsible for loss, theft, or disappearance of exhibitor's material after same has been delivered to exhibitor's booth.
- * KUB Tradeshow Support, LLC shall not be responsible for loss, theft, or disappearance of materials before they are picked up from exhibitor's booth for reloading after the show. Bill of lading covering outgoing shipments, which are furnished by KUB Tradeshow Support, LLC to exhibitor, will be checked at time of actual pick up from booth and corrections made where discrepancies occur.
- * KUB Tradeshow Support, LLC shall not be responsible for any loss, damage, or delay due to fire, Acts of God, strikes, lockouts or work stoppages of any kind or to any causes beyond its control.
- * KUB Tradeshow Support, LLC liability shall be limited to the physical loss or damage to the specific article which is lost or damaged, and in any event, KUB Tradeshow Support, LLC maximum liability shall be limited to \$.30 per pound per article with a maximum liability of \$50.00 per item, or \$1,000.00 per shipment; whichever is less.
- * KUB Tradeshow Support, LLC shall not be liable to any extent whatsoever for any actual, potential or assumed loss of profits or revenues, or for any collateral costs, which may result from any loss or damage to an exhibitor's materials which may make it impossible or impractical to exhibit same.
- * The consignment or delivery of a shipment to KUB Tradeshow Support, LLC by an exhibitor, or by any shipper to or on behalf of the exhibitor, shall be construed as an acceptance by such exhibitor (and/or other shipper) of the terms and conditions set forth.
- * Rates are based on incoming weight only. All weights are rounded off to the next 100 lb. weight. Each shipment received is considered separately. Freight handling charges are the responsibility of the exhibitor.
- * Exhibitors are urged to carry all-risk floater insurance covering their materials against damage, loss, and all other hazards from the time shipment is made prior to the show until shipments are received back after the show. This can generally be done by adding "riders" to existing insurance policies, often at no additional cost.
- * Empty container labels will be available at the Service Desk. Affixing the labels is the sole responsibility of the exhibitor or his representative. KUB Tradeshow Support, LLC assumes no responsibility for removal of containers with old empty labels, mislabeled, or valuables stored inside containers while containers are in storage.
- * Outbound shipping labels and bills of lading will be available at the Service Desk. Exhibitor or his/her representative must pack and label their exhibit material and turn in bill of lading for each shipment at the Service Desk before leaving the show. KUB Tradeshow Support, LLC will route all shipments unless a designated carrier has been assigned. If the designated carrier fails to pick up by the removal date of the show, KUB Tradeshow Support, LLC reserves the right to route exhibit material by an alternate carrier. As a result of re-routing or handling no liability will be assumed by KUB Tradeshow Support, LLC.

ADVANCE WAREHOUSE SHIPMENTS ONLY

FROM: _____

TO: _____
(EXHIBITOR NAME) (BOOTH #)

**Broward County Condo & HOA Expo
C/O KUB TRADESHOW SUPPORT, LLC
19 North Texas Avenue
Orlando, FL 32805**

ADVANCE WAREHOUSE SHIPMENTS ONLY

FROM: _____

TO: _____
(EXHIBITOR NAME) (BOOTH #)

**Broward County Condo & HOA Expo
C/O KUB TRADESHOW SUPPORT, LLC
19 North Texas Avenue
Orlando, FL 32805**

FOR ADVANCE SHIPMENTS ONLY

**DELIVER NO LATER THAN Wednesday, September 25, 2019
RECEIVING 8:00AM - 4PM MONDAY - FRIDAY, CHECK IN BY 3:30PM**

ADVANCE WAREHOUSE SHIPMENTS ONLY

FROM: _____

TO: _____
(EXHIBITOR NAME) (BOOTH #)

**Broward County Condo & HOA Expo
C/O KUB TRADESHOW SUPPORT, LLC
19 North Texas Avenue
Orlando, FL 32805**

ADVANCE WAREHOUSE SHIPMENTS ONLY

FROM: _____

TO: _____
(EXHIBITOR NAME) (BOOTH #)

**Broward County Condo & HOA Expo
C/O KUB TRADESHOW SUPPORT, LLC
19 North Texas Avenue
Orlando, FL 32805**

ON-SITE DIRECT SHIPMENTS ONLY

FROM: _____

TO: _____ (BOOTH #)

**Broward County Condo & HOA Expo
C/O KUB TRADESHOW SUPPORT, LLC
Broward County convention Center
1950 Eisenhower Blvd.
Ft. Lauderdale, FL 33316**

ON-SITE DIRECT SHIPMENTS ONLY

FROM: _____

TO: _____ (BOOTH #)

**Broward County Condo & HOA Expo
C/O KUB TRADESHOW SUPPORT, LLC
Broward County Convention Center
1950 Eisenhower Blvd.
Ft. Lauderdale, FL 34104**

FOR ON-SITE DIRECT SHIPMENTS ONLY

Show site shipments will be received beginning Wednesday, October 2, 2019 form 8am-10am.

ON-SITE DIRECT SHIPMENTS ONLY

FROM: _____

TO: _____ (BOOTH #)

**Broward County Condo & HOA Expo
C/O KUB TRADESHOW SUPPORT, LLC
Broward County Convention Center
1950 Eisenhower Blvd.
Ft. Lauderdale, FL 33316**

ON-SITE DIRECT SHIPMENTS ONLY

FROM: _____

TO: _____ (BOOTH #)

**Broward County Condo & HOA Expo
C/O KUB TRADESHOW SUPPORT, LLC
Broward Convention Center
1950 Eisenhower Blvd.
Ft. Lauderdale, FL 34104**



ORDER INSTRUCTIONS

Advance Payment Deadline Date: 09/11/19

EDLEN

The Power People

ELECTRICAL EXHIBITION SERVICES

16110 NW 13th Avenue, Miami, FL 33169
Phone: (305) 623-5335 Fax: (305) 623-5337
miami@edlen.com

EXHIBITOR:		BTH #	
EVENT:	Broward County Condo & HOA Expo Oct 2019		
FACILITY:	Greater Ft. Lauderdale Broward County Conv. Ctr.		
DATES:	October 2, 2019	EVENT #	109014MI

FOR YOUR CONVENIENCE PLACE YOUR ORDER ONLINE AT WWW.EDLEN.COM

COMPLETE THE STEPS BELOW TO PLACE UTILITY ORDERS

Step 1 Complete the Method of Payment

This form must be completed and returned with the order forms below.

Step 2 Complete Utility Order Forms as Required

- A. Electrical Order
- B. Plumbing Order
- C. Lighting Order

Step 3 Review Electrical Labor Instructions

This form will help you determine if you require electrical labor in your booth.

- A. What electrical work in your booth space needs to be performed by Edlen Electricians.
- B. How power is delivered to your booth in the facility (from the floor or ceiling).
- C. What other forms are required in order to schedule and pre-pay your estimated labor cost.

Step 4 Complete Additional Labor Forms as Required

Forms include the following:

- A. **Electrical Distribution**
This form is used for the distribution of power on the floor in your booth space. The form should be completed by all island booths. Inline and peninsula booths need to provide this information only if power is required at any location other than the rear of the booth space.
- B. **Electrical Booth Work**
This form is used to estimate electrical labor required in the construction of your booth.
- C. **Plumbing Distribution**
This form is used for the distribution of air/water & drain services in your booth space. The form should be completed by all island booths. Inline and peninsula booths need to provide this information only if plumbing is required at any location other than the rear of the booth space.

Step 5 Complete the Electrical & Plumbing Layout Forms (if applicable)

All island booths must return an electrical layout and plumbing layout (if applicable) indicating a main distribution point as well as any other locations requiring power or plumbing services. Inline and peninsula booths need to return an electrical layout only if power is needed at any other location than the rear of the booth.



METHOD OF PAYMENT

Advance Payment Deadline Date: 09/11/19

EDLEN

The Power People

ELECTRICAL EXHIBITION SERVICES

16110 NW 13th Avenue, Miami, FL 33169
Phone: (305) 623-5335 Fax: (305) 623-5337
miami@edlen.com

EXHIBITOR:		BTH #	
EVENT:	Broward County Condo & HOA Expo Oct 2019		
FACILITY:	Greater Ft. Lauderdale Broward County Conv. Ctr.		
DATES:	October 2, 2019	EVENT # 109014MI	

FINANCIALLY RESPONSIBLE COMPANY

COMPANY NAME:		PHONE:	
ADDRESS:		FAX:	
CITY:	ST:	ZIP:	
COUNTRY:		CELL #:	
EMAIL:			

METHOD OF PAYMENT

All transactions require a credit card on file with proper authorization. In addition to checks, Edlen also accepts American Express, Mastercard, Visa, Discover, ACH and Wire Transfers. Indicate form of payment below.

ACH ELECTRONIC PAYMENT TRANSFER

Wells Fargo ABA# 121000248 Acct: 4122636046
3800 Howard Hughes Parkway, Las Vegas, NV 89169
Phone: 800.289.3557

Please note the financial institution MUST be based in the US. In order to avoid a transfer fee, you must notify the financial institution that you wish to make an ACH electronic payment transfer.

BANK WIRE TRANSFER INFORMATION *

Bank transfer to Wells Fargo
Wire Transfer:
ABA#: 121000248 Acct: 4122636046
International Wire Transfer:
Swift Code: WFBIUS6S Acct: 4122636046

* Please reference the Event # listed above and your Booth # on all electronic payments.

*** \$50 processing fee MUST be included with transfer.**

CREDIT CARD

For your convenience, we will use this authorization to charge any remaining balances on your account prior to event closing. A copy of final charges will be sent to the email address provided in the payment information section.

VISA MASTERCARD AMEX DISCOVER

COMPANY CHECK

Make check payable to: Edlen Electrical. All foreign checks must be drawn on U.S. Banks only. Check must be received before the deadline date and you must include a credit card as a guarantee. Please reference the Event # listed above on your remittance.

CHECK AND CREDIT CARD INFORMATION

COMPANY NAME:	
CHECK #	
CREDIT CARD NUMBER:	EXP DATE:
CARD HOLDER SIGN:	PRINT NAME:
EMAIL:	
THIRD PARTY PAYMENT? YES or NO	

CREDIT CARD ADDRESS INFORMATION IF DIFFERENT THAN INFORMATION ABOVE

ADDRESS:	CITY:	ST:	ZIP:
-----------------	--------------	------------	-------------

SERVICE TOTALS

1. BANK WIRE TRANSFER PROCESSING FEE	
2. ELECTRICAL ORDER	
3. ESTIMATED LABOR	
4. LIGHTING ORDER	
5. PLUMBING ORDER	
SUBTOTAL	
SALES TAX due unless 3rd party providing FL DR-13 or charitable org. providing FL DR-14 must accompany order	7% SALES TAX
TOTAL DUE	

AUTHORIZATION

AUTHORIZED SIGNATURE ABOVE	
PRINT NAME ABOVE	TODAY'S DATE ABOVE

By signing and placing this order, I accept all payment policies, the terms and conditions outlined on all completed service order forms, and the Edlen General Data Protection Regulation Privacy Policy

MOP_ST.V1.MI.08.17_PG 1



ELECTRICAL ORDER E M

Advance Payment Deadline Date: 09/11/19



The Power People

ELECTRICAL EXHIBITION SERVICES

16110 NW 13th Avenue, Miami, FL 33169
 Phone: (305) 623-5335 Fax: (305) 623-5337
 miami@edlen.com

EXHIBITOR:		BTH #	
EVENT:	Broward County Condo & HOA Expo Oct 2019		
FACILITY:	Greater Ft. Lauderdale Broward County Conv. Ctr.		
DATES:	October 2, 2019	EVENT #	109014MI

FOR YOUR CONVENIENCE PLACE YOUR ORDER ONLINE AT WWW.EDLEN.COM

ORDER INSTRUCTIONS

INLINE AND PENINSULA DELIVERY
 The cost of 120-Volt outlets includes delivery to one location at the rear of inline or peninsula booths. If you require the outlet(s) to be distributed to any other location(s), material and labor charges apply. There is a minimum charge of (1) hour for installation and (1/2) hour for removal. Complete and return the Electrical Distribution Form along with a floor plan layout of your booth space indicating outlet location(s).

ISLAND BOOTH DELIVERY ONE LOCATION
 Island booths that only need power delivered to one location incur (1) hour labor charge for installation & removal. Return a floor plan layout of your booth space indicating the outlet location with measurements and orientation.

ISLAND BOOTH DELIVERY MULTIPLE LOCATIONS
 Island booths that require power to be delivered to multiple locations within their booth space incur a minimum (1) hour labor charge for installation. The removal of this work will be charged a minimum (1/2) hour or (1/2) the total time of installation. Material charges will apply. Return a floor plan layout of your booth space indicating a main distribution point and all outlet locations with measurements and orientation. If a main distribution point is not provided, Edlen will deliver to the most convenient location.

208/480V POWER DELIVERY AND CONNECTIONS
 Edlen electricians must make all high voltage connections and disconnections on a time and material basis. Complete the Electrical Booth Work Form to schedule your estimated connection time and labor. Return form with your order.

24 HOUR SERVICES
 Electricity will be turned on within 30 minutes of show opening and off within 30 minutes of show closing, show days only. If you require power at any other time order 24 hour power at double the outlet rate.

CANCELLATIONS
 Credits will not be issued for services delivered and not used. See #13, 19 & 20 on back of form for additional details.

TERMS & CONDITIONS
 I agree in placing this order that I have accepted Edlen's payment policy and the terms and conditions of the contract.

ELECTRICAL OUTLETS Approximately 120V/208V A.C. 60 Cycle - Prices are for Entire Event

	QTY Show Hours Only	QTY 24hrs/day Double rate	ADVANCE PAYMENT PRICE	REGULAR PAYMENT PRICE	TOTAL COST
120 VOLT					
500 WATTS (5 AMPS)	_____	_____	87.00	132.00	_____
1000 WATTS (10 AMPS)	_____	_____	120.00	180.00	_____
2000 WATTS (20 AMPS)	_____	_____	182.00	272.00	_____
208 VOLT SINGLE PHASE					
20 AMPS	_____	_____	292.00	417.00	_____
30 AMPS	_____	_____	348.00	497.00	_____
60 AMPS	_____	_____	517.00	738.00	_____
208 VOLT THREE PHASE					
20 AMPS	_____	_____	388.00	582.00	_____
30 AMPS	_____	_____	462.00	693.00	_____
60 AMPS	_____	_____	688.00	1032.00	_____
100 AMPS	_____	_____	987.00	1481.00	_____
200 AMPS	_____	_____	2086.00	3129.00	_____
400 AMPS	_____	_____	3233.00	4850.00	_____

TRANSFORMER(S) Boost 208 Volt to 230 Volt
 Transformer (20 amp minimum charge) Total Amps: _____ x 5.00 = _____

Please call for information on any services you require that are not listed here.

480V CONNECTIONS Approximately 480V A.C. 60 Cycle - Prices are for Entire Event

480 VOLT THREE PHASE					
20 AMPS	_____	_____	778.00	1164.00	_____
30 AMPS	_____	_____	924.00	1386.00	_____
60 AMPS	_____	_____	1376.00	2064.00	_____
100 AMPS	_____	_____	1974.00	2962.00	_____

120V RENTAL MATERIAL (Must Pick up Items at Onsite Exhibitor Service Center)

15' EXTENSION CORD	_____	26.00	_____
POWER STRIP	_____	26.00	_____

TRANSFER TOTAL TO BOX #2 ON METHOD OF PAYMENT FORM	TOTAL	_____
---	--------------	-------

PRINT NAME: _____

EMAIL: _____ PHONE: _____

TERMS & CONDITIONS

1. Order with payment & floor plan (for island booths or any booth requiring distribution of electrical services) must be received no later than the deadline date on the front of this form for advance payment rates to apply. Orders faxed or mailed without payment and required floor plan will not be guaranteed advance rates. Orders received after the deadline date will be charged at the regular rate. A purchase order or photocopy of a check are not considered valid forms of payment for securing advanced rate.
2. In the event order totals are calculated incorrectly, Edlen reserves the right to make the necessary corrections and charge the corrected amount. Exhibitors will be notified by email or fax of any such corrections.
3. Outlet rates listed include bringing services to one location at the rear of inline and peninsula booths.
4. Outlet rates listed **do not** include the connection of any equipment, special wiring, or distribution of the outlets, to other than the standard locations within the booth space. Distribution to all other locations *regardless of booth type* require labor and is performed on a time and material basis. Exhibitors are invited to contact the local Edlen office to discuss any additional costs that may be incurred.
5. A separate outlet must be ordered for each location where an electrical service is required. 5 amps or 500 watts is the minimum amount of power that can be ordered for any one location. Power must be ordered according to peak amperage ratings.
6. Island Booths - Booths that require power to be delivered to multiple locations within their booth space incur a minimum (1) hour labor charge for installation. The removal of this work will be charged a minimum (1/2) hour or (1/2) the total time of installation. Material charges will apply. Return a floor plan layout of your booth space indicating a main distribution point and all outlet locations with measurements and orientation. If a main distribution point is not provided, Edlen will deliver to the most convenient location.
7. There is a total (1) hour or (1/2) hour installation and (1/2) hour removal charge for Island Booths that require delivery to one location.
8. Labor rates are based on current wage scales and are subject to change in the event of a wage increase after rates have been published. A minimum charge of (1/2) hour labor will apply for all installation work. The removal of this work will be charged a minimum of 1/2 hour or 1/2 the total time of installation, plus material.
9. For a dedicated outlet, order a 20 amp outlet.
10. In the event 1000 watt overhead quartz lights cannot be mounted to existing catwalks in the convention hall, lift and labor charges will apply. Please contact our local office to discuss any additional charges.
11. Edlen employees are authorized to cut floor coverings when essential for installation of services unless otherwise directed.
12. Edlen is the exclusive provider of all material and equipment used in the distribution of temporary electrical services throughout the exhibit hall including the exhibitor booth space. This material is provided on a rental basis ONLY and remains the property of Edlen. It shall be removed only by Edlen employees.
13. Any extension cords or power strips ordered on the front of this form should be picked up at the Exhibitor Service Center. Credit will not be issued for unused items.
14. Standard wall and other permanent building utility outlets or sockets are not part of a booth space and may not be used by exhibitors unless electrical services have been ordered through Edlen.
15. All equipment regardless of source of power, must comply with federal, state and local codes. Edlen reserves the right to inspect all electrical devices and connections to ensure compliance with all codes, for which labor charges can be incurred. Edlen is required to refuse connections where the Exhibitor wiring or equipment is not in accordance with electrical codes.
16. All electrical equipment must be properly tagged and wired with complete information as to the type of current, voltage, phase, cycle, horsepower, etc., required for operation.
17. All Exhibitors' cords must be a minimum of 14 gauge, 3 wire and grounded. Two (2) wire extension cords are not allowed. All exposed, non-current carrying metal parts of fixed equipment which are liable to be energized, shall be grounded.
18. Payment in full must be rendered during the event. Exhibitors ARE NOT billed for services provided. Services may be interrupted if payment is not received.
19. Credit will not be given for services installed and not used. All orders are subject to a 25% cancellation fee if cancelled in writing & received by Edlen within 14 calendar days prior to show opening. Except sales tax, Edlen will not refund overpayment in amounts less than \$50.00 unless specifically requested in writing.
20. Claims will not be considered or adjustments made unless filed in writing by Exhibitor prior to the close of the event.
21. Exhibitor holds Edlen harmless for any and all losses of power beyond Edlen's control, including, but not limited to, losses due to utility company failure, permanent power distribution failure, power failure caused by vandalism, faulty Exhibitor equipment or overloads caused by Exhibitor.
22. It is agreed that in the event it becomes necessary to turn this matter over to an attorney for collection, or to file a lien, or foreclosure, or otherwise, Exhibitor will pay Edlen its attorney fees or applicable agency fees.
23. A service charge of 1.5% per month on any unpaid balances will be assessed starting 10 days after date of invoice. A \$25.00 service charge will be assessed for all returned checks and credit cards. Exhibitor agrees to reimburse Edlen for all applicable rental taxes.
24. Exhibitor hereby agrees to all terms and conditions outlined on all order forms and the Edlen General Data Protection Regulation (GDPR) privacy policy, which can be reviewed by visiting <https://ordering.edlen.com/LegalNotices/Terms-Edlen-GDPR.pdf>

COMMONLY ASKED QUESTIONS - WHERE WILL MY OUTLET BE LOCATED?

Outlets are located as depicted below for inline & peninsula booths. All other locations require labor on a time & material basis. Exhibitors with hard wall booths must make arrangements with Edlen to bring power inside the booth on a time and material basis.

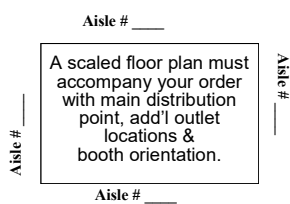
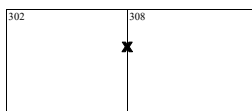
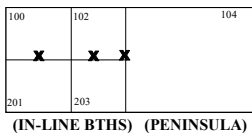

ISLAND BOOTHS

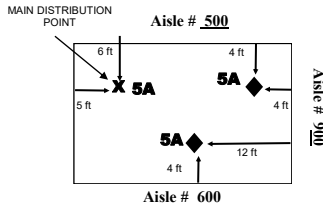

EXAMPLE-FLOOR POWER

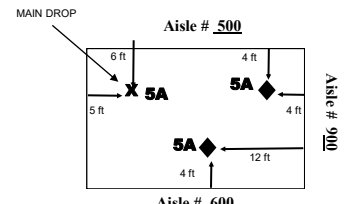

EXAMPLE-CEILING POWER

**FOR OTHER COMMONLY ASKED QUESTIONS VISIT OUR WEBSITE @ WWW.EDLEN.COM
OR CALL THE NUMBER ON THE FRONT OF THIS FORM**



The Power People

ELECTRICAL EXHIBITION SERVICES

16110 NW 13th Avenue, Miami, FL 33169
Phone: (305) 623-5335 Fax: (305) 623-5337
miami@edlen.com

EXHIBITOR:		BTH #	
EVENT:	Broward County Condo & HOA Expo Oct 2019		
FACILITY:	Greater Ft. Lauderdale Broward County Conv. Ctr.		
DATES:	October 2, 2019	EVENT #	109014MI

LABOR ORDERING INSTRUCTIONS

Step 1 Review Jurisdiction Information Below

The work outlined under Electrical Jurisdiction below must be performed by Edlen Electricians and cannot be performed by any other union or I&D House. Determine the type of work required in your booth space and complete the corresponding labor forms. The Power Delivery section indicates if power typically comes from the ceiling or the floor which may impact your booth layout.

Step 2 Complete the Appropriate Form

There are 2 different forms utilized to schedule labor in your booth space. This allows exhibitors to pre-pay the estimated labor cost. This is only an estimate. Final labor and/or lift cost may be greater or less depending on time required and minimum labor charges.

A. Electrical Distribution

This form is used for the distribution of power on the floor in your booth space. This form should be completed for all island booths. Inline and peninsula booths need to provide this information only if power is required at any other location than the rear of the booth space.

B. Electrical Booth Work

This form is used to estimate electrical labor required in the construction of your booth.

Step 3 Return the following forms to Edlen

Electrical Order, Method of Payment, applicable Labor Forms and Electrical Layout.

ELECTRICAL JURISDICTION

WORK REQUIRING EDLEN ELECTRICIANS

1. Delivery of main power line to Island Booths only
2. Electrical distribution under carpet or overhead
3. Connection of all high voltage services
4. Hardwiring of any electrical apparatus
5. Installation of lighting hung from ceiling
6. Assembly & installation of lighting hung from truss
7. Motor, truss, rigging installation and cabling

POWER DELIVERY

Power is typically delivered from the floor in this facility and is brought to one main distribution point. From this point it is distributed to all other locations in the booth space. Depending on the total power requirements an electrical panel may be placed at the main distribution point. Electrical panels utilize a minimum of 1'x1'6" floor space. Please call if you have any concerns.



ELECTRICAL DISTRIBUTION

Advance Payment Deadline Date: 09/11/19



The Power People

ELECTRICAL EXHIBITION SERVICES

16110 NW 13th Avenue, Miami, FL 33169

Phone: (305) 623-5335 Fax: (305) 623-5337

miami@edlen.com

EXHIBITOR:		BTH #	
EVENT:	Broward County Condo & HOA Expo Oct 2019		
FACILITY:	Greater Ft. Lauderdale Broward County Conv. Ctr.		
DATES:	October 2, 2019	EVENT #	109014MI

ELECTRICAL DISTRIBUTION UNDER CARPET

ALL Island booths MUST provide the information below. Inline and peninsula booths need to provide this information ONLY if power is required at any location other than the rear of the booth space. This information allows Edlen the opportunity to expedite move-in by having your power distribution complete prior to your scheduled move-in time. Complete all of the fields below including the "Labor Estimate" Section. Edlen will make every attempt to complete the work prior to your arrival, but it can not be guaranteed.

- Provide an Electrical Layout Form:
 - The electrical layout must indicate each power outlet and its location with exact measurements.
 - The electrical layout must reflect booth orientation. Use surrounding booth or aisle numbers.
 - Identify a main distribution point. Power is delivered to that point and then distributed to other locations. Inline or peninsula booths do not need to provide a main distribution point. Power will be located at the rear of the booth.
 - If power is only required in one location in Island booths, indicate that location with measurements on your electrical layout.
- What date will you begin building your booth?
 - Date: _____ Time: _____
- Will you be utilizing any specialty floor covering other than carpet, such as vinyl or wood?
 - Describe flooring: _____
 - Estimated date and time flooring installation will begin. Date: _____ Time: _____
- Show site supervisor:

Name _____ Cell # _____

Email _____ Company _____
- The exhibitor acknowledges there is a minimum 1 hour labor charge for the distribution of services and 1/2 hour for the removal of services. Island booths that only require power delivered to one location incur a 1 hour installation and removal charge.
- In the event a lift is required to deliver power from the ceiling, or if the exhibitor requests power be delivered from above when it's available on the floor, lift charges will apply for installation and removal. There is a minimum 1 hour installation and 1 hour removal cost for both lift and labor. For safety reasons lifts require a 2 man crew.

LABOR RATES AND HOURS		DISTRIBUTION LABOR ESTIMATE		
Labor Minimums	Enter a minimum of 1 hour for installation and 1/2 hour for removal. For installation labor greater than 1 hour, dismantle is 1/2 the total installation time.	MAN HRS	RATE	TOTAL
Straight Time	Monday - Friday, 8:00 AM - 4:30 PM, except Holidays.	ST	\$87.00	_____
Overtime	Monday - Friday 4:30 PM - 8:00 AM, all day Saturday, Sunday & Holidays.	OT	\$174.00	_____
		LIFT RENTAL		
		HOURS	RATE	TOTAL
		_____	\$260.00	_____
TRANSFER ESTIMATED TOTAL TO BOX #3 ON METHOD OF PAYMENT FORM		ESTIMATED TOTAL		

AUTHORIZATION

PRINT NAME:

DATE:



ELECTRICAL BOOTH WORK

Advance Payment Deadline Date: 09/11/19

EDLEN

The Power People

ELECTRICAL EXHIBITION SERVICES

16110 NW 13th Avenue, Miami, FL 33169

Phone: (305) 623-5335 Fax: (305) 623-5337

miami@edlen.com

EXHIBITOR:		BTH #	
EVENT:	Broward County Condo & HOA Expo Oct 2019		
FACILITY:	Greater Ft. Lauderdale Broward County Conv. Ctr.		
DATES:	October 2, 2019	EVENT #	109014MI

BOOTH LABOR REQUIREMENTS

The date and times completed below assist Edlen in scheduling electrical manpower. These times and number of men are not guaranteed. Otherwise, all requests are performed on a first come first serve basis. A representative must come to Edlen's service desk prior to each individual labor request time in order to confirm the booth is ready for labor. If labor is dispatched at the requested time and no "exhibitor supervision" is available, a minimum 1/2 hour labor charge per electrician applies.

Hardwiring of any Device or Apparatus (Any electrical device that does not come with a plug attached)

Day _____ Date _____ Time _____ # Elec _____ Hrs. Each _____ Total _____

Connection of High Voltage Services (208V - 480V)

Day _____ Date _____ Time _____ # Elec _____ Hrs. Each _____ Total _____

Installation of Booth Lighting

Day _____ Date _____ Time _____ # Elec _____ Hrs. Each _____ Total _____

General Booth Work (Any other work not described above where an electrician is required)

Day _____ Date _____ Time _____ # Elec _____ Hrs. Each _____ Total _____

OVERHEAD LIGHTING / OVERHEAD SIGNS / LIGHTING REQUIREMENTS

Assembly & Installation of Lighting Hung from Ceiling or in Booth (Complete Lighting Order Form)

Installation, Removal & Wiring of Overhead Signs (Complete Hanging Sign & Overhead Sign Placement Form)

LIFT RENTAL

In the event a lift is required lift charges will apply for installation and removal. There is a minimum 1 hour installation and 1 hour removal cost for both lift and labor. For safety reasons lifts require a 2 man crew.

LABOR RATES AND HOURS		BOOTH LABOR ESTIMATE		
Labor Minimums	Enter a minimum of 1 hour for installation and 1/2 hour for removal. For installation labor greater than 1 hour, dismantle is 1/2 the total installation time.	MAN HRS	RATE	TOTAL
Straight Time	Monday - Friday, 8:00 AM - 4:30 PM, except Holidays.	_____ ST	\$87.00	_____
Overtime	Monday - Friday 4:30 PM - 8:00 AM, all day Saturday, Sunday & Holidays.	_____ OT	\$174.00	_____
		LIFT RENTAL		
		HOURS	RATE	TOTAL
		_____	\$260.00	_____

TRANSFER ESTIMATED TOTAL TO BOX #3 ON THE METHOD OF PAYMENT FORM

ESTIMATED TOTAL

AUTHORIZATION

PRINT NAME:

DATE:



ELECTRICAL LAYOUT

Advance Payment Deadline Date: 09/11/19

EDLEN

The Power People

ELECTRICAL EXHIBITION SERVICES

16110 NW 13th Avenue, Miami, FL 33169
 Phone: (305) 623-5335 Fax: (305) 623-5337
 miami@edlen.com

EXHIBITOR:		BTH #	
EVENT:	Broward County Condo & HOA Expo Oct 2019		
FACILITY:	Greater Ft. Lauderdale Broward County Conv. Ctr.		
DATES:	October 2, 2019	EVENT #	109014MI

Go to the exhibitors tab at <https://www.edlen.com/exhibitor-resources/> for an exact grid to match your booth

POWER ORIGINATES FROM THE FLOOR IN THIS VENUE

Power is delivered from a floor port to a "main distribution point" in island booths and then distributed from that point. Indicate this location and all other outlet locations using the legend & grid below. Inline and peninsula booths need to provide this information only if power is needed at any other location than the rear of the booth. (See T&C page 4 for examples):

INDICATE BOOTH TYPE	INDICATE SCALE & TOTAL SQ FT	OUTLET LEGEND
Island _____ Inline _____ Peninsula _____	<p style="color: red;">Example: 1 Square = 1 Foot</p> <p>_____ Square = _____ Ft</p> <p>Total Square Footage = _____</p>	X = Main Distribution Point ▲ = 5amp/500 watt ◆ = 10amp/1000 watt ★ = 15amp/1500 watt ● = 20amp/2000 watt

Adjacent Booth or Aisle # _____

Adjacent Booth or Aisle # _____

Adjacent Booth or Aisle # _____

Adjacent Booth or Aisle # _____

EDLEN

The Power People

ELECTRICAL EXHIBITION SERVICES

16110 NW 13th Avenue, Miami, FL 33169
 Phone: (305) 623-5335 Fax: (305) 623-5337
 miami@edlen.com

EXHIBITOR:		BTH #	
EVENT:	Broward County Condo & HOA Expo Oct 2019		
FACILITY:	Greater Ft. Lauderdale Broward County Conv. Ctr.		
DATES:	October 2, 2019	EVENT # 109014MI	

FOR YOUR CONVENIENCE PLACE YOUR ORDER ONLINE AT WWW.EDLEN.COM

OVERHEAD LIGHTING (Does not include labor or lift time to install or remove)



- Ceiling mounted fixture
- Light up booth signage
- Focus on booth product
- Narrow or wide beam
- Color Gels available

Call for a quote for labor & lift cost

	QTY	ADVANCE PRICE	REGULAR PRICE	TOTAL COST
1000 WATT OVERHEAD LIGHT		247.00	372.00	
ST LABOR (Install and/or remove fixture)		87.00	87.00	
OT LABOR (Install and/or remove fixture)		174.00	174.00	
LIFT (Install and remove fixture)		260.00	260.00	

TRACK LIGHTING (Track & fixture includes power and 1 hour labor for install and removal)



- LED Par 38 3000K
- Adjustable fixtures
- Low heat
- Beam spread 23-26°
- High intensity, output lights
- Color consistency for jewelry & art

	QTY	ADVANCE	REGULAR	TOTAL
6' TRACK WITH 2 FIXTURES		143.00	229.00	
6' TRACK WITH 3 FIXTURES		173.00	259.00	
6' TRACK WITH 4 FIXTURES		203.00	289.00	
ADDITIONAL LIGHT FIXTURES		42.00	42.00	

IMPORTANT! Cross bars and stanchions to mount track must be ordered through the decorator.

ARM & POLE LIGHTS (Lights include power and 1 hour labor for install and removal)



- Arm lights must be mounted to hard wall structure
- Pole lights are placed at side rail or rear of booth
- Additional labor and material charges will apply for installation of pole lights in any other location than at the side rail or rear of inline booths

	QTY	ADVANCE	REGULAR	TOTAL
ARM LIGHT		101.00	152.00	
8 FOOT POLE LIGHT WITH 1 FIXTURE		82.00	123.00	
8 FOOT POLE LIGHT WITH 2 FIXTURES		164.00	246.00	

FLOOR PLAN	TRANSFER TOTAL TO BOX #4 ON METHOD OF PAYMENT FORM	TOTAL	
Send floor plan indicating light locations for overhead lights and pole lights	PRINT NAME:		
	EMAIL:	PHONE:	



AUDIO-VISUAL ORDER FORM

Event Name _____
 Event Dates _____

SECTION A

Flat Panel Monitors	QTY/DAY	RATES	AUDIO	QTY/DAY	RATES
	QTY. X DAYS	X RATES =		QTY. X DAYS	X RATES =
17" FLAT PANEL DISPLAY	x	\$100.00 =	Powered Speaker with Stand	x	\$90.00 =
24" FLAT PANEL DISPLAY	x	\$125.00 =	SMALL SOUND SYSTEM *	x	\$250.00 =
40" FLAT PANEL DISPLAY	x	\$250.00 =	* 2 POWERED SPEAKERS W/STANDS, MIXER, MIC		
50" FLAT PANEL DISPLAY	x	\$300.00 =	4 Channel Mixer	x	\$45.00 =
52" FLAT PANEL DISPLAY	x	\$350.00 =	Wireless Handheld or Lavalier	x	\$150.00 =
42"/50" CHROME POST STAND	x	\$125.00 =	CD PLAYER	x	\$30.00 =
			CD Record	x	\$40.00 =
			SM 58 Microphone	x	\$30.00 =

Larger Monitors Available Upon Request
 Additional Labor May Be Required For Multiple Or Larger Items.

VIDEO	QTY/DAY	RATES	PROJECTION	QTY/DAY	RATES
	QTY. X DAYS	X RATES =		QTY. X DAYS	X RATES =
DVD PLAYER (BluRay)	x	\$35.00 =	FLIPCHART W/PAD & MARKERS	x	\$35.00 =
Apple Ipad	x	\$70.00 =	TRIPOD SCREENS (6' - 7' - 8')	x	\$40.00 =
PC Laptop	x	\$175.00 =	7 1/2' x 10' Fast Fold Screen	x	\$150.00 =
Panasonic HD Camera	x	\$400.00 =	LCD PROJECTOR (3000L)	x	\$300.00 =
DVD Record	x	\$200.00 =	LCD PROJECTOR (6000L)	x	\$450.00 =
VGA Cable 50'	x	\$15.00 =	LCD PROJECTOR (12000L)	x	\$1,000.00 =
HDMI Cable 50'	x	\$20.00 =	48" PROJ./ MONITOR CART W/SKIRT	x	\$20.00 =
HDMI Distribution Amp.	x	\$60.00 =			

Larger Monitors Available Upon Request
 Specialty Equipment Available Upon Request.

BOOTH LIGHTING PACKAGES UPON REQUEST

ORDERING INSTRUCTIONS

1. After choosing quantity of equipment and days needed
2. Enter dollar amounts from section A in section B
3. Calculate your order in section B
4. Fill in billing information in section C
5. Fax to Everlast Productions @ 954-456-1243

SECTION B

CALCULATE YOUR ORDER

Equipment Total.....	_____
Add Basic Delivery/ Setup/ Pick up.....	+ \$100.00
Sub-Total.....	= _____
Add Tax @ 7%.....	+ _____
Total Charge.....	\$ _____
If Using Credit Card add 2.75% Admin.Fee to Total.....	= _____

Delivery Information

Delivery Date _____ Time _____
 Location _____

Pickup Information

Pickup Date _____ Time _____
 Location _____

SECTION C

Billing Information Please Print Clearly

Company Name: _____	On Site Contact: _____
Address: _____	
STREET	CITY STATE ZIP
Phone Number _____	Fax Number _____
Print Name _____	Signature _____ Date _____

Payment Information Circle One

CREDIT CARD
 AMX MC VISA

CARD NUMBER EXPIRATION DATE CARDHOLDER'S NAME

C.O.D.

COMPANY CHECK CHECK # CASH

Notes:
 Please Email your order form to avbcc@everlastproductions.com and include show name in the subject line.
 If the specific AV equipment needed is not listed please contact us at 954-765-5952 or 954-456-7167
 Payment will be processed after equipment is delivered and installed.
 Any electrical needs must be ordered from Edlen Electrical directly.



Telecommunications & Network Services Order
 Greater Fort Lauderdale/Broward County Convention Center

1950 Eisenhower Blvd
 Fort Lauderdale, FL 33316
 T.954-448-5847 F.866-935-8819
 http://www.cclid.net
 info@cclid.net

Event Name: _____ Booth #/Location: _____
 Company Name: _____ Event Date(s): _____
 Street Address: _____ City: _____ State: _____ Postal Code: _____
 Contact Name: _____ Telephone #: _____ Email Address: _____

PAYMENT MUST ACCOMPANY ORDER (Please make checks payable to CCLD. Note: We cannot accept checks from foreign banks nor can we accept cash.)

- Check Enclosed Visa Mastercard American Express

Credit Card Number: _____ Expiration Date: _____ Security Code: _____

I HAVE READ AND AGREE TO ALL TERMS AND CONDITIONS OF THIS ORDER. PLEASE SEE BACK PAGE FOR COMPLETE TERMS & CONDITIONS.

Signature: _____ Date: _____ Name as it appears on credit card: _____

Incentive Rates Apply to Orders Received (with payment) 21 Calendar Days PRIOR to First Open Show Date.
 ORDERS PLACED ON-SITE ARE SUBJECT TO ADDITIONAL INSTALLATION CHARGES.

TELECOMMUNICATIONS SERVICES	INCENTIVE RATES	BASE RATES	QUANTITY	TOTAL
Switched Telephone Line (Must dial 9 for an outside line)	\$ 235	\$ 270		
Polycom Conference Phone	\$ 180	\$ 230		

A credit card must be supplied with this order for long distance service to be provided.

INTERNET & NETWORK SERVICES	INCENTIVE RATES	BASE RATES	QUANTITY	TOTAL
High-Speed Internet Lite Private IP Address, up to 128kbps per computer	\$ 420	\$ 510		
High-Speed Internet Standard Private IP Address, up to 256kbps per computer	\$ 750	\$ 870		
High-Speed Internet Premium (Recommended for VPN Users) Up to 5 mbps, additional devices may be added; each computer utilizing connection must have a CCLD-approved IP address.	\$ 1,100	\$ 1,250		
Additional Network Devices (Utilizing Premium Service)	\$ 145	\$ 190		
16-Port Hub Rental	\$ 145	\$ 190		
50-Foot CAT-5 Patch Cable	\$ 50	\$ 75		
100-Foot CAT-5 Patch Cable	\$ 75	\$ 100		

Customer may utilize their own router (wired or wireless) and cables when using the premium wired service if desired. CCLD does require that an Additional Device/IP Address be purchased for each device utilizing the Premium Wired Internet service.

DEDICATED BANDWIDTH WIRED INTERNET SERVICES	INCENTIVE RATES	BASE RATES	QUANTITY	TOTAL
Dedicated 3Mbps Bandwidth Connection	\$ 3,995	\$ 4,595		
Dedicated 5Mbps Bandwidth Connection	\$ 5,995	\$ 6,595		
Dedicated 10Mbps Bandwidth Connection	\$ 9,995	\$ 10,595		

Dedicated services work well for high bandwidth applications such as webcasting, streaming media, etc. Larger increments of dedicated bandwidth are available upon request.

Subtotal :	
10% Sales Tax / Surcharge :	
Total :	

To ensure proper placement in your booth, please attach a scaled drawing showing service locations with reference to adjacent aisle numbers or booths. If not received, CCLD will place services in the center of the booth. Requests to change location of services will be subject to a \$150.00 Relocation Charge.

TERMS AND CONDITIONS

1. **Lease of Equipment.** CCLD agrees to lease and provide to Customer, and Customer agrees to lease and obtain from CCLD, the equipment and service described herein or on attached supplement(s), for the rental payment set forth herein, or on such attached supplement (plus all sales, use, and all other taxes due to federal, state, or local taxing authorities, if any, on the lease of equipment and provision of service here under). **Payment For Which Must Accompany Service Orders.**
2. **Term.** The equipment and services will be provided during the dates of the relevant show set forth on the CCLD Service Order Form, subject to the other provisions of this agreement. Prices are subject to change without notice.
3. **Use of PBX Switch and Related Services.** Customer's rental of the equipment shall include the usage of (but not physical access to) the common telecommunication equipment (collectively, the "Switch") serving the Customer at the convention facility identified on the CCLD Service Order Form (the "Building").
4. **Local Exchange Telephone Services.** Local exchange telephone services will be provided by the local telephone company's exchange services and facilities.
5. **Long Distance.** Long distance (interchange) services are provided by CCLD under license agreements with center management (1+ dialing) or arrangements directly between Customer and such other parties (0+ dialing). CCLD or other such parties may process billing for such service. Billing or other questions relating to long distance services should be directed initially to CCLD at the number shown on the CCLD Service Order Form. A \$0.75 surcharge per call will be charged on all Directory Assistance, Toll Free Numbers and Credit Card Calls.
6. **Request for Service; Payment.**
 - (a) Request for special arrangements must be received by CCLD no less than thirty (30) days prior to initial move in date. Custom/ Fiber orders must be received at least 60 days prior to move in date.
 - (b) Personal checks will be accepted with Advance Rate requests only.
 - (c) There will be \$50.00 service charge for all returned checks.
7. **Equipment Management.** CCLD will collect telephone sets, hubs and other equipment after the event. Please leave equipment at the location it was installed or please call our office when you are ready to return it.
8. **Cancellations.** The equipment and services are being provided by CCLD under a license agreement with the building owner or manager. CCLD may cancel this Agreement and its obligations by notice to customer in the event such license agreement expires or is terminated, in which event CCLD's only obligation shall be to refund any advanced payments made by Customer.
9. **Customer's Duties.**
 - (a) Customer will use the equipment in a careful and proper manner. Customer shall not make any alterations, attachments, or additions to the equipment without CCLD's written consent. Only CCLD employees or approved personnel are authorized to modify system wiring.
 - (b) Customer shall be liable for any loss or damage to the equipment arising from Customer's negligence, intentional act, unauthorized maintenance other cause within the reasonable control of Customer, its representatives, employees, agents, or invitees. In the event of any loss or damage to the equipment for which Customer is liable, Customer shall reimburse CCLD for the reasonable cost of the repair or replacement. **You will be charged upon non-return of the equipment.** Standard Telephone Sets, \$75.00 each; Multi-line Sets, \$300.00 each; Speaker Phone Sets, \$75.00 each; Fax Machines, \$500.00 each; Polycom Sets, \$300.00 each; Hubs, \$300.00 each. Any additional equipment rented by CCLD will have an agreed upon non-return charge amount at time of rental.
 - (c) The equipment shall remain the sole and exclusive property of CCLD or its assignee, and nothing contained herein shall give or convey to Customer any right, title or interest whatever in the equipment which shall, at all times, be and remain personal property notwithstanding that it may be or become attached to or embedded in the realty.
10. **Events of Customer Default.** Customer shall be in default hereunder if Customer fails to pay when due any rental payment or service charge or any other indebtedness to CCLD, or Customer fails to return equipment to CCLD when required to do so hereunder fails to perform or observe any other obligation or covenant to be performed or observed by Customer hereunder. **No credit will be given for equipment or service cancelled after installation date. Installation date is same as Show Move in date. A \$55.00 process charge per service will be applied to any orders cancelled prior to move in date.**
11. **Remedies of CCLD.** At any time after a default by the Customer, CCLD may terminate this Agreement, by notice to Customer, and repossess the equipment, whereupon customers' right to use the equipment shall cease but Customer shall remain liable for all unpaid charges, and CCLD may apply and retain all or such portion of customers deposit as may be necessary to compensate CCLD for any unpaid charges or damages and expenses incurred on account of such default, or CCLD may exercise any other rights accruing to a lessor under any applicable law upon a default by a lessee.
12. **Limitation of Liability.**
 - (a) CCLD's obligations under this Agreement are subject to, and CCLD shall not be liable for delays, failure to perform or damage or destruction or malfunction of the equipment or services or any consequence of any of the above, caused, occasioned or due to fire, flood, water, the elements, labor disputes or shortages, utility curtailments, power failure, explosions, civil disturbances, government regulatory requirements, acts of God or public enemy, war, military or government requisition, shortages of equipment or supplies, unavailability of transportation, acts or omissions of anyone other than CCLD, its representatives, agents or employees, or any other cause beyond CCLD's reasonable control.
 - (b) In all situations involving performance or non-performance of equipment or related programs of services furnished under this Agreement, the Customer's sole and exclusive remedy and CCLD's sole and exclusive liability will be (i) the adjustment or repair of the equipment or replacement of the its parts by CCLD or at CCLD's option, replacement of the equipment, or correction of programming errors or (ii) if, after reasonable and repeated efforts, CCLD is unable to install the equipment or replacement equipment in good working order, or to restore the same to good working order, or to make programming operate, the Customer shall be entitled to terminate this Agreement and receive a refund equal to the excess (if any) of (1) the total amount theretofore paid by Customer to CCLD for equipment and services under this Agreement, or (2) the reasonable value of Customer's use of the equipment and services.
 - (c) **In no event shall CCLD be liable to the Customer or to any other party for special collateral, exemplary, indirect, incidental, or consequential damages, whether such damages occur either prior or subsequent to, or are alleged as a result of, fortuitous conduct, failure of the equipment or services of CCLD or breach of any of the provisions of this Agreement, regardless of the form of action, whether in contract or in tort, including strict liability and negligence, even if CCLD has been advised of the possibility of such damages, or for any damages caused by the Customer's failure to perform the Customer's responsibilities. Such excluded damages include, but are not limited to, loss of profits, loss of use or interruption of business, or other consequential of indirect economic loss.**
 - (d) Customer acknowledges and agrees that neither the owner of the building nor the prime licensee of other party responsible for the event in which the Customer is participating is responsible for the provision of the equipment or the services, and that neither such party shall be liable to Consumer for any failure or defect in such equipment or services.
 - (e) Claims will not be considered unless filed in writing with CCLD by Customer prior to the close of the event identified on the order form submitted.
13. **Indemnification.** Customer hereby assumes liability for and agrees to indemnify, protect and hold wholly harmless CCLD and its agents, employees, officers, directors, and any and all successors and assigns, from and against any and all liabilities, obligations, losses, damages, injuries, claims, demands, penalties, actions, costs, and expenses, including reasonable attorney's fees, in contract, in tort or otherwise, which result from and arise out of the negligent or wrongful use of the equipment or the services, or from the acts or omissions of the Customer or its representatives, agents, employees, or invitees.
14. **Assignment.** CCLD shall have the right to assign its interest under the Agreement to any other party subsequently providing equipment and services to the building.
15. **Entire Agreement; Amendment.** This Agreement and any attached supplement(s) constitute the entire agreement between the parties hereto and supercedes all prior oral or written discussions or agreements. This Agreement may be amended only by a written agreement executed between both parties.
16. **Governing Law.** This Agreement shall be construed under the laws of the state in which the building is located.
17. **Cellular Air Time (Usage).** Cellular services are billed by license agreements with CCLD. Billing for such services will be billed separately by CCLD.
18. **Wireless Applications.** Users of wireless hardware (e.g. 802.11) and/or applications must contact CCLD to coordinate frequency usage.
19. **Exclusivity.** CCLD is the exclusive voice/data communications provider for the BCCC. As such all outside proxy servers, routers, or any machine used to propagate a single I.P. address to multiply devices are forbidden. Each device, which has the ability to see the internet, must have an I.P. address purchased for that device.



Exhibit Services

Reliable trade show shipping services





The show must go on!

YRC Freight is ready to customize transportation solutions for any exhibit shipment, any size load, delivering great service, savings and simplicity.

After the show, specify YRC Freight for the move out on the materials handling agreement (MHA), then give us a call. We'll take it from there.

And if others handle your trade show shipping, remember to tell them about YRC Freight savings and service.

Delivering confidence at the show

- 100% inbound service guarantee* at no additional cost
- On-site Exhibit managers monitor your inbound shipments for on-time, smooth move ins
- Time-Critical expedited
- Comprehensive North American coverage and online visibility

Giving you more for your money

- Lowest trade show shipping fees in the industry
- 30 days free storage prior to the show; a great way to save when moving from show to show
- No detention fees at trade shows
- No extra fees for weekend/after-hour pickups

Keeping it simple for you

- Exhibit customer service representatives available 24/7; call 1-800-531-EXPO (3976)
- Around-the-clock assistance with quotes, bookings, tracking or expediting
- Single-shipment transportation for your entire display
- Online shipment visibility throughout the move on my.yrcfreight.com
- Specialized Brokerage services designed specifically for cross-border trade show shipping needs

* Subject to applicable Tariffs and Rules and Conditions publications.

yrcfreight.com | 800.531.EXPO (3976) |  Live Chat



Accent

TRADESHOW & EVENT FURNISHINGS

CUSTOM FURNITURE



Accent on Service...
Accent on Excellence

www.GetAccent.com

CORDOBA... BLACK LEATHER



CM-1 Cordoba Sofa - Black Leather



CM-2 Cordoba Loveseat - Black Leather



CM-3 Cordoba Chair - Black Leather

CM-1 Sofa - Black Leather
80"L x 31"D x 33"H

CM-2 Loveseat - Black Leather
56"L x 31"D x 33"H

CM-3 Chair - Black Leather
33"L x 31"D x 33"H



CHARGED!



CONCORD... WHITE LEATHER



C-4 Concord Sofa - White Leather



 C-4C Concord Sofa w/ Charging Console - White Leather



C-5 Concord Loveseat
White Leather



 C-5C Concord Loveseat w/ Charging Console
White Leather



C-6 Concord Chair
White Leather

C-4 Sofa - White Leather 79.5"L x 32"D x 34.5"H	C-5 Loveseat - White Leather 56"L x 32"D x 34.5"H	C-6 Chair - White Leather 33"L x 32"D x 34.5"H
C-4C Sofa - White Leather w/ Charging Console 87"L x 32"D x 34.5"H	C-5C Loveseat - White Leather w/ Charging Console 63.5"L x 32"D x 34.5"H	



CONCORD



CONTEMPO...WHITE OR BLACK LEATHER



- I-1 Contempo Curve Sofa
White Leather
- I-4 Contempo Curve Sofa
Black Leather



- I-2 Contempo Curve Bench
White Leather
- I-5 Contempo Curve Bench
Black Leather



- I-3 Contempo Round Ottoman
White Leather
- I-6 Contempo Round Ottoman
Black Leather

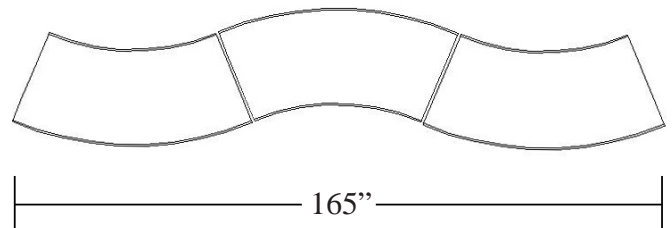
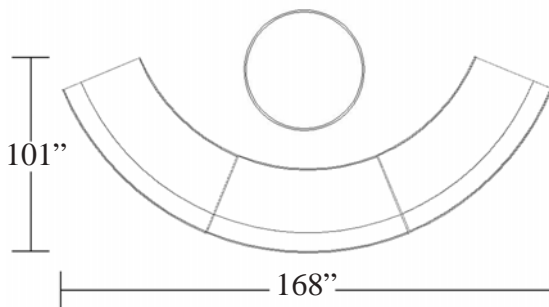

I-1 Curve Sofa - White Leather
71"L x 34"D x 30"H

I-4 Curve Sofa - Black Leather
71"L x 34"D x 30"H

I-2 Curve Bench - White Leather
71"L x 34"D x 17"H

I-5 Curve Bench - Black Leather
71"L x 34"D x 17"H

I-3 Round Ottoman - White Leather
40"L x 40"D x 17"H

I-6 Round Ottoman - Black Leather
40"L x 40"D x 17"H

LAREDO... BLACK LEATHER



C-1 Laredo Sofa - Black Leather



C-2 Laredo Loveseat - Black Leather



C-3 Laredo Chair - Black Leather

SOUTH BEACH... WHITE OR RED LEATHER



E-1 South Beach Sofa - White Leather
 E-4 South Beach Sofa - Red Leather



E-2 South Beach Chair White Leather
 E-5 South Beach Chair Red Leather



E-3 South Beach Bench White Leather
 E-6 South Beach Bench Red Leather

C-1 Sofa - Black Leather
77"L x 34"D x 32"H

C-2 Loveseat - Black Leather
54"L x 34"D x 32"H

C-3 Chair - Black Leather
32"L x 34"D x 32"H

E-1 Sofa - White Leather
85"L x 34"D x 32"H

E-2 Chair - White Leather
53"L x 34"D x 32"H

E-3 Bench - White Leather
53"L x 27"D x 16"H

E-4 Sofa - Red Leather
77"L x 34"D x 32"H

E-5 Chair - Red Leather
53"L x 34"D x 32"H

E-6 Bench - Red Leather
53"L x 27"D x 16"H



MELROSE... RED SUEDE



G-1 Melrose Sofa - Red Suede



G-2 Melrose Chair - Red Suede



G-3 Melrose Bench - Red Suede

G-1 Sofa - Red Suede
78"L x 41"D x 30"H

G-2 Chair - Red Suede
40"L x 36"D x 30"H

G-3 Bench - Red Suede
61"L x 21"D x 17"H



MODERN... WHITE LEATHER & CHROME

H-5 Modern Sofa
White Leather
72"L x 31"D x 26"H

H-6 Modern Chair
White Leather
35"L x 32"D x 27"H



H-5 Modern Sofa - White Leather



H-6 Modern Chair - White Leather

I-10 Da Vinci Sofa
White Leather
74"L x 35"D x 36"H
Flat (74"L x 48"D x 18"H)



I-10 Da Vinci Sofa - White Leather



Sofa Folds into Flat Bench



MONTE CARLO...WHITE OR BLACK LEATHER



- H-1 Monte Carlo Loveseat
Black Leather
- H-3 Monte Carlo Loveseat
White Leather

- H-2 Monte Carlo Corner
Black Leather
- H-4 Monte Carlo Corner
White Leather

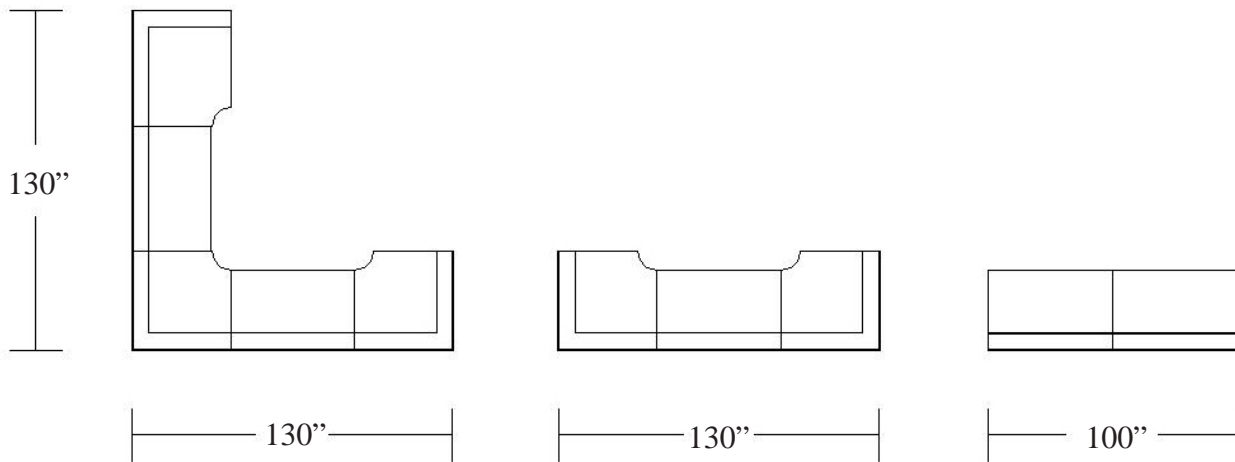

H-1 Loveseat - Black Leather
50"L x 38"D x 29"H

H-2 Corner - Black Leather
40"L x 40"D x 29"H

H-3 Loveseat - White Leather
50"L x 38"D x 29"H

H-4 Corner - White Leather
40"L x 40"D x 29"H



UPTOWN... BLACK SUEDE



A-1 Uptown Sofa - Black Suede



A-2 Uptown Loveseat - Black Suede



A-3 Uptown Chair - Black Suede



A-4 Uptown Bench - Black Suede

A-1 Sofa - Black Suede
83"L x 32"D x 32"H

A-2 Loveseat - Black Suede
59"L x 32"D x 32"H

A-3 Chair - Black Suede
39"L x 32"D x 32"H

A-4 Bench - Black Suede
61"L x 20"D x 17"H



NEWPORT... TAN SUEDE



B-1 Newport Sofa - Tan Suede



B-2 Newport Loveseat - Tan Suede



B-3 Newport Chair - Tan Suede

B-1 Sofa - Tan Suede
79"L x 34"D x 32"H

B-2 Loveseat - Tan Suede
54"L x 34"D x 32"H

B-3 Chair - Tan Suede
32"L x 34"D x 32"H



ACCENT CHAIRS...

F-7 Stage Chair
Black Leather
27"L x 23"D x 35"H

F-8 Stage Chair
Burgundy Leather
27"L x 23"D x 35"H

F-9 Stage Chair
White Leather
27"L x 23"D x 35"H



F-7



F-8



F-9

I-9 Glove Chair - White Leather
30"L x 30"D x 32"H

E-18 Aspen Chair
White Leather
30.5"L x 28"D x 30"H



I-9



E-18



F-1

F-2



F-3

F-4



F-5

F-6

F-1 Barcelona Chair - Red Leather
31"L x 35"D x 33"H

F-2 Barcelona Ottoman - Red Leather
24"L x 24"D x 17"H

F-3 Barcelona Chair - White Leather
31"L x 35"D x 33"H

F-4 Barcelona Ottoman - White Leather
24"L x 24"D x 17"H

F-5 Barcelona Chair - Black Leather
31"L x 35"D x 33"H

F-6 Barcelona Ottoman - Black Leather
24"L x 24"D x 17"H



CHARGED!

**Electric Required for following CHARGED products*



E-14C



E-15C



M-5J



I-1C



P-13C

E-14C Tall Pub Table - White Charged
60"L x 25"D x 42"H

E-15C Short Pub Table - White Charged
60"L x 25"D x 30"H

ADD LIGHTING
*E-UL Under Lighting Add-on
*Available on E-8C, E-14C, and E-15C

M-5J Bar Table - White/Chrome Charged
30"Dia x 42"H

I-1C Contempo Curve Sofa
White Leather - Charged
71"L x 34"D x 30"H

P-13C White Laminant
Conference Table - Charged
53"L x 33"D x 29"H



CHARGED!

**Electric Required for following CHARGED products*



E-11 Charged Sofa
White Leather



E-12 Charged Loveseat
White Leather



E-13 Charged Chair
White Leather



E-11 Sofa - White Leather - Charged
72"L x 31"D x 32"H

E-12 Loveseat - White Leather - Charged
55"L x 31"D x 32"H

E-13 Chair - White Leather - Charged
33"L x 31"D x 32"H



E-10C
White Cube End Table - Charged
(Multi Device Charging Cable)



D-6C
Black Cube End Table - Charged
(Multi Device Charging Cable)



E-8C

E-10C End Table - White Cube - Charged
20"L x 20"D x 20"H

D-6C End Table - Black Cube - Charged
24"L x 24"D x 20"H

E-8C Cocktail - White Rectangle - Charged
47"L x 23"D x 16"H

OCCASIONAL TABLES...



I-7



I-8



A-10



A-11



B-4



B-5



D-4



D-5



D-6

** Also Available Charged (D-6C)*

I-7 Cocktail - Chrome / Glass
45"L x 32"D x 18"H

A-10 Cocktail - Black / Glass
48"L x 24"D x 17"H

B-4 Cocktail - Natural
48"L x 24"D x 17"H

D-4 Cocktail - Black Square
30"L x 30"D x 16"H

I-8 End Table - Chrome / Glass
21"Dia x 21"H

A-11 End Table - Black / Glass
21"L x 21"D x 21"H

B-5 End Table - Natural
24"Dia x 21"H

D-5 Cocktail - Black Cylinder
30"Dia x 15"H

D-6 End Table - Black Cube
24"L x 24"D x 20"H



OCCASIONAL TABLES...



E-7



E-8



E-9

** Also Available Charged (E-8C)*



E-10

** Also Available Charged (E-10C)*



E-19



CM-4



CM-5



CM-6



CM-7

E-7 Cocktail - White Square
31"L x 31"D x 15"H

E-8 Cocktail - White Rectangle
47"L x 23"D x 16"H

E-9 End Table - White Square
20"L x 20"D x 19"H

E-10 End Table - White Cube
20"L x 20"D x 20"H

E-19 Side Table - White
10"L x 18"D x 25"H

CM-4 Cocktail Table - Wood Grain
44"L x 22"D x 17"H

CM-5 End Table - Wood Grain
19.5"L x 19.5"D x 21"H

CM-6 Cocktail Table - White
44"L x 22"D x 17"H

CM-7 End Table - White
19.5"L x 19.5"D x 21"H



OTTOMANS & BENCHES...

- J-12 Black Cube Ottoman
17"L x 17"D x 17"H
- J-13 Orange Cube Ottoman
17"L x 17"D x 17"H
- J-14 White Cube Ottoman
17"L x 17"D x 17"H
- J-15 Red Cube Ottoman
17"L x 17"D x 17"H
- J-16 White Swivel Ottoman
18"Dia x 17.25"H
- J-17 Orange Swivel Ottoman
18"Dia x 17.25"H
- J-18 Black Swivel Ottoman
18"Dia x 17.25"H
- G-4 LED Cube - Glow
20"L x 20"D x 20"H
- J-10 White Storage Cube
18"L x 18"D x 17"H
- J-11 Black Leather Ottoman
18"L x 18"D x 18"H



J-12



J-13



J-14



J-15



J-16



J-17



J-18



GLOW G-4
ADJUSTABLE COLORS



J-10



J-11



E-6



E-3

E-6 South Beach Bench
Red Leather
53"L x 27"D x 16"H

E-3 South Beach Bench
White Leather
53"L x 27"D x 16"H



J-19



A-4

J-19 Rustic Wood Bench
59"L x 16"D x 17.5"H

A-4 Uptown Bench
Black Suede
61"L x 20"D x 17"H

WORK STATIONS...



E-14

** Also Available Charged (E-14C)*



E-15

** Also Available Charged (E-15C)*

E-14 Tall Pub Table - White
60"L x 25"D x 42"H

E-15 Short Pub Table - White
60"L x 25"D x 30"H

O-10 Parson Desk - Black
48"L x 24"D x 29"H

J-20 Work Station - Black
57"L x 24"D x 40"H

J-21 Work Station - White
57"L x 24"D x 40"H



O-10



J-21



J-20

L-24 Anaheim Chair - White
18"L x 20"D x 36"H

J-1 Dynamic Chair - Black
23"L x 24"D x 32"H

J-2 Dynamic Chair - Green
23"L x 24"D x 32"H

J-3 Dynamic Chair - Orange
23"L x 24"D x 32"H

J-4 Dynamic Chair - White
23"L x 24"D x 32"H

L-3 Maple / Chrome Chair
16"L x 18"D x 31"H

L-9B Chair - Black / Chrome
16"L x 18"D x 31"H

L-9R Chair - Red / Chrome
16"L x 18"D x 31"H

L-9W Chair - White / Chrome
16"L x 18"D x 31"H

K-5 Euro Chair - Black
22"L x 23"D x 28"H

K-6 Jet Black Chair
16"L x 18"D x 31"H

M-16 Gunmetal Chair
18"L x 21"D x 34"H

L-21 Chrome Chair
24"L x 18"D x 29"H

M-1 Chair - Blue / Black
20"L x 20"D x 32"H

M-3 Chair - Red / Black
20"L x 20"D x 32"H

M-3B Chair - Black / Black
20"L x 20"D x 32"H



SEATING... CHAIRS



J-1



J-2



J-3



J-4



L-3



L-9B



L-9R



L-9W



K-5



K-6



M-16



L-21



■ M-1 Blue / Black

■ M-3 Red / Black

■ M-3B Black / Black



L-7W

L-1 Table - Maple / Chrome
30"Dia x 29"H

L-2 Table - Maple / Chrome
36"Dia x 29"H

L-7W Table - White / Chrome
30"Dia x 29"H

L-7S Table - White Square
30"L x 30"D x 29"H

L-7 Table - Black / Chrome
30"Dia x 29"H

L-8 Table - Black / Chrome
36"Dia x 29"H

K-1 Table - Black
24"Dia x 29"H

K-2 Table - Black
30"Dia x 29"H

K-3 Table - Black
36"Dia x 29"H

K-4 Table - Black
42"Dia x 29"H

L-7R Table - Rustic
30" L x 30"D x 30"H

L-20 Table - Chrome
30"Dia x 29"H

L-14 Glass Table - Black
(Rounded Corners)
42"Dia x 29"H

L-15 Glass Table - Chrome
36"Dia x 29"H

SHORT TABLES...



L-1 (30"Diam)
L-2 (36"Diam)



L-7W



L-7S



L-7 (30"Diam)
L-8 (36"Diam)



K-1 (24"Diam)
K-2 (30"Diam)
K-3 (36"Diam)
K-4 (42"Diam)



L-7R



L-20



L-14



L-15

L-6 Barstool - Maple / Chrome
16"L x 18"D x 42"H

L-12W Barstool - White / Chrome
16"L x 18"D x 42"H

L-12B Barstool - Black / Chrome
16"L x 18"D x 42"H

L-12R Barstool - Red / Chrome
16"L x 18"D x 42"H

L-18 Swivel Stool
White / Chrome - Adj
15"L x 15"D x 25" - 33"H

L-18B Swivel with Back
White / Chrome - Adj
23"L x 17"D x 42"H

L-19 Swivel Stool
Black / Chrome - Adj
15"L x 15"D x 25" - 33"H

K-10 Euro Stool - Black
21"L x 20"D x 41"H

K-11 Jet Black Stool
16"L x 18"D x 42"H

L-23 Stool - Chrome
20"L x 16"D x 39"H

M-6 Curve Barstool
White / Chrome - Adj
17"L x 18"D x 35"H

M-14 Crescent Stool
White / Chrome - Adj
22"L x 19"D x 40"H

M-15 Gunmetal Barstool
18"L x 18"D x 29"H

M-13 Scoop - White
17"L x 22" - 33"H - Adj

M-10 Scoop - Red
17"L x 22" - 33"H - Adj

M-11 Scoop - Grey
17"L x 22" - 33"H - Adj

M-12 Scoop - Black
17"L x 22" - 33"H - Adj

M-4 Barstool - Red / Black
20"L x 22"D x 45"H - Swivel

M-4B Barstool - Black / Black
20"L x 22"D x 45"H - Swivel

M-2 Barstool - Blue / Black
20"L x 22"D x 45"H - Swivel



L-6



L-12W



L-12B



L-12R

SEATING... BARSTOOLS



L-18



L-18B



L-19



K-10



K-11



L-23



M-6



M-14



M-15



□ M-13 White Scoop

■ M-10 Red Scoop

■ M-11 Grey Scoop

■ M-12 Black Scoop



■ M-4 Red / Black

■ M-4B Black / Black

■ M-2 Blue / Black



L-10 (30"Diam)
L-11 (36"Diam)

L-4 Bar Table - Maple / Chrome
30"Dia x 42"H

L-5 Bar Table - Maple / Chrome
36"Dia x 42"H

M-5 Bar Table - White / Chrome
30"Dia x 42"H

M-5S Bar Table - Square
White / Chrome
30"L x 30"D x 42"H

L-10 Bar Table - Black / Chrome
30"Dia x 42"H

L-11 Bar Table - Black / Chrome
36"Dia x 42"H

K-7 Bar Table - Black
24"Dia x 42"H

K-8 Bar Table - Black
30"Dia x 42"H

K-9 Bar Table - Black
36"Dia x 42"H

M-5R Bar Table - Square
Rustic
30"L x 30"D x 42"H

L-17 Bar Table - Glass / Chrome
31.5"Dia x 42"H

L-22 Bar Table - Chrome
30"Dia x 42"H

M-7 Gelato Table - White
24"Dia x 31" - 40"H - Adj

M-8 Gelato Table - Grey
24"Dia x 31" - 40"H - Adj

M-9 Gelato Table - Black
24"Dia x 31" - 40"H - Adj

TALL BAR TABLES...



L-4 (30"Diam)
L-5 (36"Diam)



M-5

** Also Available Charged (M-5J)*



M-5S



L-10 (30"Diam)
L-11 (36"Diam)



K-7 (24"Diam)
K-8 (30"Diam)
K-9 (36"Diam)



M-5R



L-17



L-22



M-7



M-8



M-9

N-1 Pedestal - Black
12"L x 12"D x 30"H

N-2 Pedestal - Black
12"L x 12"D x 36"H

N-3 Pedestal - Black
12"L x 12"D x 42"H

N-4 Pedestal - Grey
12"L x 12"D x 30"H

N-5 Pedestal - Grey
12"L x 12"D x 36"H

N-6 Pedestal - Grey
12"L x 12"D x 42"H

N-7 Pedestal - Black
18"L x 18"D x 36"H

N-8 Pedestal - Black
18"L x 18"D x 42"H

N-9 Pedestal - Grey
18"L x 18"D x 36"H

N-10 Pedestal - Grey
18"L x 18"D x 42"H

N-15 Pedestal - White
18"L x 18"D x 36"H

N-16 Pedestal - White
18"L x 18"D x 42"H

N-11 Pedestal - Black
24"L x 24"D x 42"H

N-12 Pedestal - Grey
24"L x 24"D x 42"H

N-13 Locking Pedestal - Black
24"L x 24"D x 42"H

N-13C Locking Pedestal - Black
(Charged) 24"L x 24"D x 42"H

N-14 Locking Pedestal - White
24"L x 24"D x 42"H

N-14 C Locking Pedestal - White
(Charged) 24"L x 24"D x 42"H



N-13

DISPLAY PEDESTALS & KIOSKS...

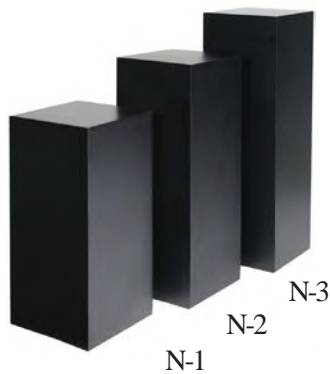

N-1

N-2

N-3



N-4

N-5

N-6



N-7

N-8

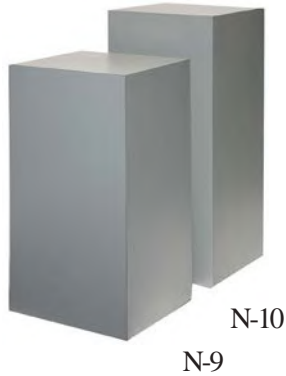

N-9

N-10



N-15



N-16



N-11



N-12



■ N-13 Black
□ N-14 White



■ N-13C Black - Charged
□ N-14C White - Charged



*Electric Required for Bar Lighting Options

O-4

O-1 Martini Bar
50" L x 50" D x 47" H

O-2 Martini Bar with
Colored Lighting.
50" L x 50" D x 47" H

O-3 Cosmopolitan Bar
72" L x 27" D x 42" H

O-4 Cosmopolitan Bar with
Lighting Option
72" L x 27" D x 42" H

BARS & RECEPTION COUNTERS...



O-1

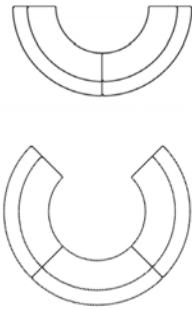

O-2

O-5 Reception
Counter - Black
48" L x 16" D x 42" H

O-6 Contour
Counter with Literature
Holder - Black
45" L x 21" D x 41" H

O-7 Contour
Counter with Literature
Holder - Grey
45" L x 21" D x 41" H



O-3



O-5



O-6



O-7

P-16 Table - White
79"L x 36"D x 30"H

P-1 Table - Maple 6ft
72"L x 36"D x 29"H

P-2 Table - Maple 8ft
96"L x 48"D x 29"H

P-3 Table - Mahogany 6ft
72"L x 36"D x 29"H

P-4 Table - Mahogany 8ft
96"L x 48"D x 29"H

P-5 Table - Mahogany 10ft
120"L x 48"D x 29"H

P-6 Table - Honey Oak 6ft
72"L x 36"D x 29"H

P-6B Table - Honey Oak 6ft
72"L x 36"D x 29"H
(Charged)

P-6C Table - Honey Oak 8ft
96"L x 36"D x 29"H
(Charged)

P-7 Table - Black Oval 6ft
72"L x 36"D x 29"H

P-8 Table - Black Oval 8ft
96"L x 48"D x 29"H

P-9 Table - Black Oval 10ft
120"L x 48"D x 29"H

P-10 Table - Grey Oval 6ft
72"L x 36"D x 29"H

P-11 Table - Grey Oval 8ft
96"L x 48"D x 29"H

P-13 Chrome Table - White
Frosted Glass Top
53"L x 33"D x 29"H

P-14 Table - Honey Oak
42"Dia x 29"H
P-14C (Charged)

P-15 Table - Mahogany
42"Dia x 29"H

P-13C Chrome Table - White
Laminant Top - Charged
53"L x 33"D x 29"H



P-16

CONFERENCE TABLES...



P-1 6ft
P-2 8ft



P-3 6ft
P-4 8ft
P-5 10ft



P-6 6ft
P-6B 6ft - Charged
P-6C 8ft - Charged



P-7 6ft
P-8 8ft
P-9 10ft



P-10 6ft
P-11 8ft



P-13



P-14
P-14C - Charged



P-15



P-13C - Charged

CONFERENCE CHAIRS...



Q-1



Q-3



Q-4

Q-1 Leather Executive - Black
25"L x 28"D x 43"H

Q-3 Leather Izzo - White
25"L x 28"D x 42"H

Q-4 Leather Izzo - Black
25"L x 28"D x 42"H

Q-5 Jr. Executive - Black
24"L x 25"D x 38"H

Q-6 Jr. Executive - Grey
24"L x 25"D x 38"H

Q-7 Sled Chair - Black
24"L x 24"D x 32"H

Q-8 Sled Chair - Grey
24"L x 24"D x 32"H

Q-9 Breuer Chair - Black/
Chrome
19"L x 23"D x 31"H

Q-10 Breuer Chair - Grey/
Chrome
19"L x 23"D x 31"H



Q-5



Q-6



Q-7



Q-8

Q-11 Drafting Stool - Black
20"L x 23"D x 51"H
Seat Height 23"-33"H Adj

Q-12 Drafting Stool - Grey
20"L x 23"D x 51"H
Seat Height 23"-33"H Adj

Q-13 Secretarial Chair - Black
20"L x 23"D x 36"H
Seat Height 16'-21"H Adj

Q-14 Secretarial Chair - Grey
20"L x 23"D x 36"H
Seat Height 16'-21"H Adj



Q-9



Q-10



Q-11



Q-12



Q-13



Q-14

O-18 iPad Stand - White
41"H x 14"Dia Base

O-19 iPad Stand - Black
41"H x 14"Dia Base



O-22 Stanchion Pole - Chrome
39" H

O-23 Stanchion Rope
6.5' Burgundy

O-24 Stanchion Rope
6.5' Black

ACCESSORIES...

O-25 Park Bench - Black
50"L x 21"D x 35"H

O-11 Refrigerator
20"L x 20"D x 34"H
115 Volts / 155.25 Watts



O-22 Stanchion Pole
O-23 Burgundy Rope
O-24 Black Rope



O-25

O-12 Coat Rack
21" x 21" Base x 68" H

A-12 Floor Lamp - Silver
72" H

O-13 Free Standing Mirror
20"W x 58"H

O-14 Literature Stand
6 pocket
10"L x 9"H x 64"H

O-15 Folding Literature Stand
Silver
11"L x 15"D x 60"H

O-16 Folding Literature Stand
Black
11"L x 15"D x 60"H

O-20 Universal Tablet Stand
Adjustable from 29"H - 43.5"H



O-11



O-12



A-12



O-13



O-14



O-15



O-16



O-20



R-1



R-2

R-1 Etagere - Black
(Glass Shelves)
30"L x 14"D x 67"H

R-2 Etagere - Chrome
(Glass Shelves)
30"L x 14"D x 67"H

R-3 Bookcase - Grey
36"L x 12"D x 48"H

R-4 Bookcase - Black
36"L x 12"D x 48"H

R-5 Bookcase - Grey
36"L x 12"D x 72"H

R-6 Bookcase - Black
36"L x 12"D x 72"H

R-7 Filing Cabinet - Grey
(2 drawer)
15"L x 26.5"D x 28.5"H

R-8 Filing Cabinet - Black
(2 drawer)
15"L x 25"D x 28.5"H

R-9 Filing Cabinet - Black
(4 drawer)
15"L x 25"D x 52"H

R-10 Storage Cabinet - Grey
36"L x 18"D x 42"H

R-11 Storage Cabinet - Black
36"L x 18"D x 42"H

R-12 Storage Cabinet - Black
36"L x 18"D x 72"H



R-3



R-4



R-5



R-6



R-7



R-8



R-9



R-10



R-11



R-12

SHELVING & STORAGE...

S-1 Desk - Natural / Black
60"L x 30"D x 29"H

S-2 Credenza - Natural / Black
60"L x 20"D x 29"H

S-3 Desk - Honey Oak
60"L x 30"D x 29"H

S-4 Credenza - Honey Oak
60"L x 20"D x 29"H

S-5 Desk - Mahogany
60"L x 30"D x 29"H

S-6 Credenza - Mahogany
60"L x 20"D x 29"H



OFFICE... DESKS



S-1



S-2



S-3



S-4



S-5



S-6



ACCENT TRADESHOW & EVENT FURNISHINGS
 3438 Maggie Blvd. * Orlando FL 32811 * 407-648-7474
 Email order to john@getaccent.com



Orders received within 14 days of event are subject to a 20% Late Fee
 25% cancellation will be applied if canceled 7 days prior to event opening
 Check or Credit Card must accompany order

100% cancellation will be applied if canceled on day of delivery
 All showsite orders are subject to a 25% service charge
 Additional drayage fees may apply from the Contractor. Refer to your Exhibit Manual

v018.1

Item #	Description	Price	Item #	Description	Price
Lounge			F-6	Barcelona Ottaman Black	\$184.00
A-1	Uptown Black Suede Sofa	\$476.00	Stage Chairs		
A-2	Uptown Black Suede Loveseat	\$430.00	F-7	Black Stage Chair	\$185.00
A-3	Uptown Black Suede Chair	\$295.00	F-8	Burgundy Stage Chair	\$185.00
A-4	Uptown Black Suede Bench Ottoman	\$269.00	F-9	White Stage Chair	\$185.00
A-10	Black / Glass Cocktail Table	\$178.00	Lounge		
A-11	Black / Glass End Table	\$161.00	G-1	Melrose Red Swirl Sofa	\$545.00
A-12	Silver Floor Lamp	\$86.00	G-2	Melrose Red Swirl Chair	\$345.00
Lounge			G-3	Melrose Red Swirl Bench	\$269.00
B-1	Newport Tan Suede Sofa	\$476.00	Glow		
B-2	Newport Tan Suede Loveseat	\$430.00	G-4	GLOW LED Cube	\$195.00
B-3	Newport Tan Suede Chair	\$295.00	Lounge		
B-4	Natural Cocktail Table	\$178.00	H-1	Monte Carlo Black Leather Loveseat	\$448.00
B-5	Natural End Table	\$161.00	H-2	Monte Carlo Black Leather Chair	\$328.00
Lounge			H-3	Monte Carlo White Leather Loveseat	\$448.00
C-1	Laredo Black Leather Sofa	\$476.00	H-4	Monte Carlo White Leather Chair	\$328.00
C-2	Laredo Black Leather Loveseat	\$430.00	H-5	Modern White / Chrome Sofa	\$495.00
C-3	Laredo Black Leather Chair	\$295.00	H-6	Modern White / Chrome Chair	\$295.00
C-4	White Leather Sofa	\$545.00	Lounge		
C-4C	White Leather Sofa w/ Charging Console	\$595.00	I-1	Contempo White Curve Sofa	\$520.00
C-5	White Leather Loveseat	\$495.00	I-1C	Contempo White Curve Sofa - CHARGED	\$595.00
C-5C	White Leather Loveseat w/ Charging Console	\$545.00	I-2	Contempo White Curve Bench	\$316.00
C-6	White Leather Chair	\$295.00	I-3	Contempo White Round Ottoman	\$241.00
CM-1	Cordoba Black Leather Sofa	\$476.00	I-4	Contempo Black Curve Sofa	\$520.00
CM-2	Cordoba Black Leather Loveseat	\$430.00	I-5	Contempo Black Curve Bench	\$316.00
CM-3	Cordoba Black Leather Chair	\$295.00	I-6	Contempo Black Round Ottoman	\$241.00
CM-4	Cordoba Wood Grain Rectangle Cocktail Table	\$178.00	I-7	Chrome / Glass Cocktail Table	\$201.00
CM-5	Cordoba Wood Grain Square End Table	\$161.00	I-8	Chrome / Glass End Table	\$178.00
CM-6	Cordoba White Rectangle Cocktail Table	\$178.00	I-9	White / Chrome Glove Chair	\$282.00
CM-7	Cordoba White Square End Table	\$161.00	I-10	Da Vinci White Leather Sofa	\$515.00
Lounge			Chairs, Ottomans, Work Stations		
D-4	Black Cube Cocktail Table	\$184.00	J-1	Dynamic Chair - Black	\$144.00
D-5	Black Round Cocktail Table	\$184.00	J-2	Dynamic Chair - Green	\$144.00
D-6	Black Cube End Table	\$167.00	J-3	Dynamic Chair - Orange	\$144.00
D-6C	Black Cube End Table - CHARGED	\$197.00	J-4	Dynamic Chair - White	\$144.00
Lounge			J-10	White Leather Storage Cube	\$105.00
E-1	South Beach White Leather Sofa	\$545.00	J-11	Black Leather Ottoman	\$105.00
E-2	South Beach White Leather Chair	\$345.00	J-12	Black Cube Ottoman	\$105.00
E-3	South Beach White Leather Bench	\$269.00	J-13	Orange Cube Ottoman	\$105.00
E-4	South Beach Red Leather Sofa	\$545.00	J-14	White Cube Ottoman	\$105.00
E-5	South Beach Red Leather Chair	\$345.00	J-15	Red Cube Ottoman	\$105.00
E-6	South Beach Red Leather Bench	\$269.00	J-16	White Swivel Ottoman	\$105.00
E-7	White Square Cocktail Table	\$172.00	J-17	Orange Swivel Ottoman	\$105.00
E-8	White Rectangle Cocktail Table	\$172.00	J-18	Black Swivel Ottoman	\$105.00
E-8C	White Rectangle Cocktail Table - CHARGED	\$247.00	J-19	Rustic Bench	\$241.00
E-9	White Square End Table	\$161.00	J-20	Black Work Station	\$375.00
E-10	White Cube End Table	\$225.00	J-21	White Work Station	\$375.00
E-10C	White Cube End Table - CHARGED	\$255.00	Tables, Chairs, Bar Stools		
E-11	White Sofa With Outlet - CHARGED	\$595.00	K-1	Black Table 24" Dia	\$132.00
E-12	White Loveseat With Outlet - CHARGED	\$495.00	K-2	Black Table 30" Dia	\$132.00
E-13	White Chair With Outlet - CHARGED	\$395.00	K-3	Black Table 36" Dia	\$150.00
E-14	Tall White Pub Table	\$420.00	K-4	Black Table 42" Dia	\$178.00
E-14C	Tall White Pub Table - CHARGED	\$495.00	K-5	Black Euro Chair	\$120.00
E-U4L	Under-Lighting Add-On	\$50.00	K-6	Jet Black Chair	\$120.00
E-15	Short White Pub Table	\$350.00	K-7	Black Tall Bar Table 24" Dia	\$172.00
E-15C	Short White Pub Table -CHARGED	\$425.00	K-8	Black Tall Bar Table 30" Dia	\$172.00
E-18	White Aspen Chair	\$328.00	K-9	Black Tall Bar Table 36" Dia	\$184.00
E-19	White & Chrome Side Table	\$85.00	K-10	Black Bar Stool	\$145.00
Lounge			K-11	Jet Black Bar Stool	\$150.00
F-1	Barcelona Chair Red	\$395.00	L-1	Maple / Chrome Table 30" Dia	\$150.00
F-2	Barcelona Ottaman Red	\$184.00	L-2	Maple / Chrome Table 36" Dia	\$161.00
F-3	Barcelona Chair White	\$395.00	L-3	Maple / Chrome Chair	\$120.00
F-4	Barcelona Ottaman White	\$184.00	L-4	Maple / Chrome Tall Bar Table 30" Dia	\$178.00
F-5	Barcelona Chair Black	\$395.00	L-5	Maple / Chrome Tall Bar Table 36" Dia	\$184.00

Tables, Chairs, & Bar Stools				Accessories			
L-6	Maple / Chrome Bar Stool		\$150.00	O-10	Parson Desk		\$245.00
L-7	Black / Chrome Table		\$138.00	O-11	Refrigerator - 3.6 CuFt (155 Volt)		\$200.00
L-7S	White / Chrome Square Table 30"		\$138.00	O-12	Coat Rack		\$115.00
L-7R	RUSTIC Square Table 30"		\$138.00	O-13	Free Standing Mirror		\$150.00
L-7W	White / Chrome Table 30" Dia		\$138.00	O-14	Literature Stand - 6 Pocket		\$126.00
L-8	Black / Chrome Table 36" Dia		\$155.00	O-15	Silver Folding Literature Stand		\$145.00
L-9B	Black / Chrome Chair		\$120.00	O-16	Black Folding Literature Stand		\$145.00
L-9R	Red / Chrome Chair		\$120.00	O-18	Ipad Stand - White		\$126.00
L-9W	White / Chrome Chair		\$120.00	O-19	Ipad Stand - Black		\$126.00
L-10	Black / Chrome Tall Bar Table 30" Dia		\$178.00	O-20	Universal Tablet Stand		\$126.00
L-11	Black / Chrome Tall Bar Table 36" Dia		\$184.00	O-22	Chrome Stanchion (Pole only)		\$50.00
L-12B	Black / Chrome Bar Stool		\$150.00	O-23	Burgundy Rope for Stanchion (Rope Only)		\$30.00
L-12R	Red / Chrome Bar Stool		\$150.00	O-24	Black Rope for Stanchion (Rope Only)		\$30.00
L-12W	White / Chrome Bar Stool		\$150.00	O-25	Park Bench - Black		\$168.00
L-14	Glass / Black Table 42" Dia.		\$155.00	Conference Tables			
L-15	Glass / Chrome Table 36" Dia		\$150.00	P-1	6' Maple Conf. Table		\$395.00
L-17	Glass / Chrome Bar Table 28" Dia		\$195.00	P-2	8' Maple Conf. Table		\$445.00
L-18	White / Chrome Swivel Stool		\$135.00	P-3	6' Mahogany Conf. Table		\$395.00
L-18B	White / Chrome Swivel Stool w/ Back		\$150.00	P-4	8' Mahogany Conf. Table		\$445.00
L-19	Black / Chrome Swivel Stool		\$135.00	P-5	10' Mahogany Conf. Table		\$569.00
L-20	Chrome Table 30" Dia		\$155.00	P-6	6' Honey Oak Conf. Table		\$345.00
L-21	Chrome / Chrome Chair		\$120.00	P-6B	6' Honey Oak Conf. Table - CHARGED		\$445.00
L-22	Chrome Tall Bar Table 30" Dia		\$184.00	P-6C	8' Honey Oak Conf. Table - CHARGED		\$495.00
L-23	Chrome Barstool		\$145.00	P-7	6' Black Conf. Table		\$385.00
L-24	White / Chrome Anaheim Chair		\$120.00	P-8	8' Black Conf. Table		\$445.00
M-1	Blue / Black Chair		\$120.00	P-9	10' Black Conf. Table		\$569.00
M-2	Blue / Black Barstool		\$150.00	P-10	6' Grey Conf. Table		\$395.00
M-3	Red / Black Chair		\$120.00	P-11	8' Grey Conf. Table		\$445.00
M-4	Red / Black Barstool		\$150.00	P-13	4.4' Frosted Wht Glass Top/Chrome Conf. Table		\$375.00
M-4B	Black / Black Barstool		\$150.00	P-13C	4.4' White / Chrome Conference Table - Charged		\$450.00
M-5	Tall Bar Table - White / Chrome		\$175.00	P-14	42" Dia Honey Oak Round Conf. Table		\$265.00
M-5J	Tall Bar Table - White / Chrome - CHARGED		\$225.00	P-14C	42" Dia Honey Oak Round Conf. Table - CHARGED		\$295.00
M-5R	Tall Square Bar Table - Rustic / Chrome		\$175.00	P-15	42" Dia Mahogany Round Conf. Table		\$265.00
M-5S	Tall Square Bar Table - White / Chrome		\$175.00	P-16	6.5' White Conference Table		\$565.00
M-6	White / Chrome Curve Barstool		\$145.00	Conference Chairs			
M-7	Gelato Table - White		\$195.00	Q-1	Black Leather Executive Chair		\$225.00
M-8	Gelato Table - Grey		\$195.00	Q-3	White / Chrome Leather Executive Chair		\$276.00
M-9	Gelato Table - Black		\$195.00	Q-4	Black / Chrome Leather Executive Chair		\$276.00
M-10	Scoop - Red		\$145.00	Q-5	Black Jr. Executive Chair		\$190.00
M-11	Scoop - Grey		\$145.00	Q-6	Grey Jr. Executive Chair		\$190.00
M-12	Scoop - Black		\$145.00	Q-7	Black Sled Chair		\$161.00
M-13	Scoop - White		\$145.00	Q-8	Grey Sled Chair		\$161.00
M-14	White / Chrome Crescent Stool		\$150.00	Q-9	Black / Chrome Breuer Chair		\$135.00
M-15	Gunmetal Bar Stool		\$150.00	Q-10	Grey / Chrome Breuer Chair		\$135.00
M-16	Gunmetal Chair		\$120.00	Q-11	Black Drafting Stool		\$172.00
Display Pedestals				Q-12	Grey Drafting Stool		\$172.00
N-1	12x12x30 Black Pedestal		\$172.00	Q-13	Black Secretarial Chair		\$144.00
N-2	12x12x36 Black Pedestal		\$184.00	Q-14	Grey Secretarial Chair		\$144.00
N-3	12x12x42 Black Pedestal		\$195.00	Office			
N-4	12x12x30 Grey Pedestal		\$172.00	R-1	Black Etagere (Glass Shelves)		\$184.00
N-5	12x12x36 Grey Pedestal		\$184.00	R-2	Chrome Etagere (Glass Shelves)		\$184.00
N-6	12x12x42 Grey Pedestal		\$195.00	R-3	48" Grey Bookcase		\$150.00
N-7	18x18x36 Black Pedestal		\$207.00	R-4	48" Black Bookcase		\$150.00
N-8	18x18x42 Black Pedestal		\$218.00	R-5	72" Grey Bookcase		\$172.00
N-9	18x18x36 Grey Pedestal		\$207.00	R-6	72" Black Bookcase		\$172.00
N-10	18x18x42 Grey Pedestal		\$218.00	R-7	2-Dr Grey File Cabinet		\$150.00
N-11	24x24x42 Black Pedestal		\$230.00	R-8	2-Dr Black File Cabinet		\$150.00
N-12	24x24x42 Grey Pedestal		\$230.00	R-9	4-Dr Black File Cabinet		\$165.00
N-13	24x24x42 Blk Storage Kiosk Locking Door		\$316.00	R-10	42" Grey Storage Cabinet		\$165.00
N-13C	24x24x42 Blk Storage Kiosk Locking Door -CHARGED		\$381.00	R-11	42" Black Storage Cabinet		\$165.00
N-14	24x24x42 Wht Storage Kiosk Locking Door		\$316.00	R-12	72" Black Storage Cabinet		\$195.00
N-14C	24x24x42 Wht Storage Kiosk Locking Door -CHARGED		\$381.00	S-1	Natural / Black Desk		\$405.00
N-15	18x18x36 White Pedestal		\$207.00	S-2	Natural / Black Credenza		\$360.00
N-16	18x18x42 White Pedestal		\$218.00	S-3	Honey Executive Desk		\$405.00
Bars				S-4	Honey Credenza		\$360.00
O-1	Martini Bar - Black / Chrome / Glass		\$875.00	S-5	Mahogany Desk		\$405.00
O-2	Martini Bar - Black / Chrome / Glass*with Lighting		\$975.00	S-6	Mahogany Credenza		\$360.00
O-3	Cosmopolitan Bar		\$857.00				
O-4	Cosmo Bar *with Light Feature		\$975.00				
O-5	Reception Counter		\$275.00				
O-6	Black Contour Reception Counter		\$385.00				
O-7	Grey Contour Reception Counter		\$385.00				